



## **Cimarron Trailers, Inc.**

**MODEL: CIMARRON GOOSENECK AND BUMPER PULL  
TRAILERS**

### **⚠ WARNING**

This User's Manual contains safety information and instructions for your trailer.

You must read this manual before loading or towing your trailer.

You must follow all safety precautions and instructions.

Cimarron Trailers, Inc.  
1442 Hwy 62 East  
PO Box B  
Chickasha, OK 73023  
405-222-4800 Phone  
405-222-4844 Facsimile  
Revised 2019

## KEY CODES FOR REPLACEMENT KEYS

Door Key # \_\_\_\_\_

Additional Key #'s \_\_\_\_\_

For replacements please visit [www.bauerproducts.com](http://www.bauerproducts.com)

Equalizer Jack Key # \_\_\_\_\_

For replacements please contact 800-846-9659

Battery Box Key # \_\_\_\_\_

For replacements please contact CIMARRON TRAILERS

Combination Dead Bolt Code # \_\_\_\_\_

For original install code contact CIMARRON TRAILERS

# Table of Contents

## CIMARRON GOOSENECK AND BUMPER PULL TRAILERS

<b>1</b>	<b>INTRODUCTION .....</b>	<b>1</b>
1.1	WELCOME TO THE CIMARRON TRAILERS TEAM.....	1
1.2	MODELS OF CIMARRON TRAILERS.....	2
1.3	WARRANTY INFORMATION .....	2
1.4	DISCLAIMER.....	2
<b>2</b>	<b>GENERAL SAFETY INFORMATION .....</b>	<b>5</b>
2.1	SAFETY ALERT SYMBOLS AND SIGNAL WORDS .....	5
2.2	MAJOR HAZARDS.....	6
2.2.1	<i>Improper Sizing of the Trailer to the Tow Vehicle</i> .....	6
2.2.2	<i>Driving Too Fast</i> .....	7
2.2.3	<i>Adjust Driving Behavior When Towing a Trailer</i> .....	7
2.2.4	<i>Improper Loading</i> .....	8
2.2.5	<i>Unsafe Load Distribution</i> .....	9
2.2.6	<i>Trailer Not Properly Coupled to the Hitch</i> .....	10
2.2.7	<i>Proper Use of Safety Chains</i> .....	11
2.2.8	<i>Proper Connection of Breakaway Brake</i> .....	11
2.2.9	<i>Matching Trailer and Hitch</i> .....	12
2.2.10	<i>Worn Tires, Loose Wheels and Lug Nuts</i> .....	12
2.2.11	<i>Shifting Cargo</i> .....	14
2.2.12	<i>Inappropriate Cargo</i> .....	15
2.2.13	<i>Inoperable Brakes, Lights or Mirrors</i> .....	16
2.2.14	<i>Hazards From Modifying Your Trailer</i> .....	17
2.2.15	<i>Hazards to Horses (Horse Trailer)</i> .....	17
2.2.16	<i>Hazards to Livestock (Livestock Trailer)</i> .....	18
2.2.17	<i>Hazards from Accessories</i> .....	19
2.2.18	<i>Safety Warning Labels on Your Trailer</i> .....	20
2.2.19	<i>Trailer Towing Guide</i> .....	21
2.2.20	<i>Reporting Safety Defects</i> .....	23
<b>3</b>	<b>TIRE SAFETY INFORMATION .....</b>	<b>24</b>
3.1	TRAILER TIRE INFORMATION .....	25
3.2	STEPS FOR DETERMINING CORRECT LOAD LIMIT – TRAILER.....	26
3.2.1	<i>Trailers 10,000 Pounds GVWR or Less</i> .....	28
3.2.2	<i>Trailers Over 10,000 Pounds GVWR</i> .....	28
3.3	STEPS FOR DETERMINING CORRECT LOAD LIMIT – TOW VEHICLE .....	29
3.4	GLOSSARY OF TIRE TERMINOLOGY .....	29
3.5	TIRE SAFETY – EVERYTHING RIDES ON IT .....	35
3.5.1	<i>Safety First–Basic Tire Maintenance</i> .....	36
3.5.2	<i>Finding Your Vehicle's Recommended Tire Pressure and Load Limits</i> .....	36

# Table of Contents

## CIMARRON GOOSENECK AND BUMPER PULL TRAILERS

3.5.3	<i>Understanding Tire Pressure and Load Limits</i> .....	36
3.5.4	<i>Checking Tire Pressure</i> .....	37
3.5.5	<i>Steps for Maintaining Proper Tire Pressure</i> .....	37
3.5.6	<i>Tire Size</i> .....	38
3.5.7	<i>Tire Tread</i> .....	38
3.5.8	<i>Tire Balance and Wheel Alignment</i> .....	39
3.5.9	<i>Tire Repair</i> .....	39
3.5.10	<i>Tire Fundamentals</i> .....	39
3.5.10.1	Information on Trailer (ST) Tires .....	40
3.5.10.2	UTQGS Information .....	41
3.5.10.3	Additional Information on Light Truck Tires .....	42
3.5.11	<i>Tire Safety Tips</i> .....	43
<b>4</b>	<b>COUPLING TO THE TOW VEHICLE</b> .....	<b>44</b>
4.1	USE AN ADEQUATE TOW VEHICLE AND HITCH .....	44
4.1.1	<i>Trailer Information</i> .....	44
4.1.2	<i>Tow Vehicle</i> .....	46
4.2	COUPLING AND UNCOUPLING THE TRAILER .....	48
4.2.1	<i>Trailer with Ball Hitch Coupler</i> .....	51
4.2.1.1	Before coupling the trailer to the tow vehicle .....	52
4.2.1.2	Prepare the coupler and hitch .....	53
4.2.1.3	Couple the trailer to the tow vehicle .....	53
4.2.1.4	Rig the safety chains .....	55
4.2.1.5	Attach and test electric breakaway brake system .....	56
4.2.1.6	Connect the electrical connector .....	59
4.2.1.7	Uncoupling the ball hitch trailer .....	60
4.2.2	<i>Trailer with Gooseneck Coupler</i> .....	60
4.2.2.1	Before coupling the trailer to the tow vehicle .....	62
4.2.2.2	Prepare the ball receiver and gooseneck ball .....	63
4.2.2.3	Couple the trailer to the tow vehicle .....	64
4.2.2.4	Rig the safety chains .....	67
4.2.2.5	Attach and test the breakaway brake system .....	68
4.2.2.6	Connect the electrical connector .....	71
4.2.2.7	Uncoupling the gooseneck trailer .....	72
4.2.3	<i>Adjust Gooseneck Hitch Height</i> .....	74
<b>5</b>	<b>LOADING THE TRAILER</b> .....	<b>76</b>
5.1	CHECKING TONGUE WEIGHT .....	78
5.2	SECURING THE CARGO .....	79
5.3	LOADING HORSES (HORSE TRAILER) .....	79
5.3.1	<i>Preparing the Horse Trailer for Loading</i> .....	80
5.3.2	<i>Loading the Horse Trailer</i> .....	81
5.4	LOADING LIVESTOCK (LIVESTOCK TRAILER) .....	84

# Table of Contents

## CIMARRON GOOSENECK AND BUMPER PULL TRAILERS

5.4.1	Preparing the Livestock Trailer for Loading .....	85
5.4.2	Loading the Livestock Trailer .....	85
5.5	LOADING CARGO (CARGO TRAILERS) .....	86
5.5.1	Preparing the Cargo Trailer for Loading .....	87
5.5.2	Loading the Enclosed Trailer .....	87
<b>6</b>	<b>CHECKING THE TRAILER BEFORE AND DURING EACH TOW</b>	<b>89</b>
6.1	PRE-TOW CHECKLIST .....	89
6.2	MAKE REGULAR STOPS .....	89
<b>7</b>	<b>BREAKING-IN A NEW TRAILER</b> .....	<b>90</b>
7.1	RETIGHTEN LUG NUTS AT FIRST 10, 25 & 50 MILES .....	90
7.2	ADJUST BRAKE SHOES AT FIRST 200 MILES .....	90
7.3	SYNCHRONIZING THE BRAKE SYSTEMS .....	91
<b>8</b>	<b>ACCESSORIES</b> .....	<b>92</b>
8.1	ELECTRIC/HYDRAULIC LANDING GEAR .....	93
8.2	AIR RIDE SUSPENSION .....	93
8.3	WINDOWS .....	94
8.4	RECESSED PADDLE LATCHES & STRIKER PLATE .....	94
8.5	BAR LOCK LATCH & CARGO VISE CATCH .....	97
8.6	DROP-DOWN FEED DOORS .....	99
8.7	STALL DIVIDERS .....	101
8.8	DOORS, GATES AND RAMPS .....	102
8.8.1	Livestock Center Gate .....	103
8.8.2	Rear Ramp Over Rear Doors .....	104
8.8.3	Full Height Side Ramp Door .....	105
8.8.4	Rear Ramp And Storm Doors .....	106
8.9	TACK ROOM .....	107
8.9.1	Front Walk-in Tack Room .....	107
8.9.2	Rear Fold-Away Tack Compartment .....	107
8.9.3	Solid Rear Tack Compartment .....	108
8.10	SADDLE TREE .....	109
8.10.1	Removable Saddle Tree .....	110
8.10.2	Saddle Tree Adjustments .....	111
8.11	REMOVABLE CENTER POST .....	112
8.12	SLIDING GATE LATCH .....	113
8.13	LIVESTOCK TRAVELING CENTER GATE .....	113
8.14	SMALL ANIMAL PENS .....	115
8.15	SLIDEOUT .....	115

# Table of Contents

## CIMARRON GOOSENECK AND BUMPER PULL TRAILERS

<b>9</b>	<b>INSPECTION, SERVICE &amp; MAINTENANCE.....</b>	<b>118</b>
9.1	INSPECTION, SERVICE & MAINTENANCE CHARTS .....	118
9.2	INSPECTION AND SERVICE INSTRUCTIONS.....	121
9.2.1	<i>Axle Bolts, Frame, Suspension, &amp; Structure</i> .....	121
9.2.2	<i>Trailer Body</i> .....	122
9.2.2.1	Cleaning.....	122
9.2.2.2	Fasteners and frame members.....	124
9.2.2.3	Welds.....	125
9.2.2.4	Roof Seal .....	125
9.2.3	<i>Door Hinges</i> .....	126
9.2.4	<i>Trailer Brakes</i> .....	127
9.2.4.1	Brake shoes and drums .....	127
9.2.4.2	Manually adjusting brake shoes.....	127
9.2.4.3	Brakes, Electric.....	127
9.2.4.4	Brakes, Hydraulic (air or electric operated).....	128
9.2.5	<i>Trailer Connection to Tow Vehicle</i> .....	129
9.2.5.1	Coupler and ball .....	129
9.2.5.2	Gooseneck .....	130
9.2.6	<i>Landing Leg or Jack</i> .....	131
9.2.7	<i>Lights and Signals</i> .....	131
9.2.8	<i>Accessory Battery</i> .....	131
9.2.9	<i>Tires</i> .....	132
9.2.10	<i>Wheel Rims</i> .....	133
9.2.11	<i>Wheels, Bearings and Lug Nuts</i> .....	133
9.2.11.1	Wheel bearings (Axles up to 7,000 lb).....	134
9.2.11.2	Wheel bearings (Axles over 7,000 lb) .....	135
9.2.12	<i>Lug Nuts (Bolts)</i> .....	135
<b>10</b>	<b>ELECTRICAL DIAGRAMS.....</b>	<b>137</b>
<b>11</b>	<b>WARRANTY INFORMATION .....</b>	<b>141</b>
<b>12</b>	<b>SERVICE RECORD.....</b>	<b>149</b>

# 1 INTRODUCTION

## 1.1 WELCOME TO THE CIMARRON TRAILERS TEAM

Thank you for purchasing your new Cimarron trailer. You have now joined an ever-growing team of quality conscience Cimarron trailer buyers.

Cimarron Trailers, Inc. was started as a family owned and operated business in 2000. As of November 2018, Cimarron is now an employee owned and operated ESOP. Products manufactured by Cimarron Trailers, Inc., are designed and manufactured to give you many years of reliable service. The combination of quality materials and top craftsmanship continues to put Cimarron Trailers above the rest.

The safety and comfort of your cargo, whether animal, auto or freight, is the highest priority in every Cimarron Trailer design and manufacturing phase. We are proud to offer animal-safe engineering in every horse and stock trailer model produced. However, as a responsible trailer owner, it is your responsibility to be familiar with your new trailer, follow safety guidelines and the recommended maintenance instructions to ensure you have many years of safe hauling.

As you begin to use your new Cimarron trailer, this User's Manual will allow you to become more familiar with the operation, maintenance and care of your trailer. This manual will reference excerpts from other manufacturer's manuals which have components on Cimarron Trailers products.

The material contained in this publication is both generalized and specific. This manual is designed to give you general information about your trailer.

# Introduction

## **1.2 MODELS OF CIMARRON TRAILERS**

This publication pertains to all trailers produced within any of the following models.

Norstar – Deluxe horse trailer models

Winstar – Combination horse/stock trailer models

Lonestar – Stock trailer models

Showstar – Low profile small animal models

Stierwalt – Show cattle models

Transtar – Cargo/auto trailer models

## **1.3 WARRANTY INFORMATION**

Upon receiving this manual, you should have also received a warranty registration form, survey and a postage-paid envelope to return them in. After your warranty registration is received by Cimarron Trailers Inc., it will be on file should you require any type of warranty related repairs. **IF YOUR WARRANTY REGISTRATION FORM IS NOT ON FILE, THE WARRANTY CANNOT BE HONORED.** A copy of the warranty registration form (after completion) should be retained for your files. The survey will be forwarded to the marketing department for use in research and product development.

When a trailer is sold, traded in or leaves the initial owner, it is the responsibility of the owner to transfer this manual to the receiving party.

## **1.4 DISCLAIMER**

All trailers manufactured by Cimarron Trailers, Inc. are designed to be used within the specific engineering guidelines. These guidelines are determined by the type of trailer, i.e. horse, stock, cargo, or auto. It is suggested that all trailers are to be used as designated by the manufacturer. At no time is it suggested or approved in any trailer manufactured by Cimarron Trailers, Inc. for the use of any carbon monoxide producing apparatus in an enclosed area. Some devices may release fumes, flames, smoke or other hazardous emissions, which could result in serious injury or possible death due to asphyxiation.

## Introduction

Cimarron Trailers Inc. assumes no responsibility for the misuse or improper operation of towing trailers, nor the results from neglecting to follow manufacturers' recommended instructions and maintenance guidelines. Failure to comply with suggested guidelines could result in nullification of warranty.

Cimarron Trailers custom designs and manufacturers trailers to fit the very specific individual requirements of our customers. We pride ourselves in our technical knowledge, experience, and sincere desire to fulfill our customer's needs and requests. However, in the pursuit of these goals, there are countless changes and variations to designs, engineering, specifications and materials, that from time to time create unforeseen or unknown circumstances which compromise the information in this owners manual.

Cimarron Trailers, Inc. reserves the right to make any change in design or construction as necessary for engineering. All visual representation, specification and guidelines are based on the latest product information available at the time of this publication. All trailers manufactured by Cimarron Trailers Inc., are covered in this publication, with minor exceptions. For more information, call or write: 405/222-4800, toll free 1-877-CTM-TRLR, Cimarron Trailers P.O. Box B, Chickasha, OK 73023, e-mail: [info@cimarrontrailers.com](mailto:info@cimarrontrailers.com), web site: [www.cimarrontrailers.com](http://www.cimarrontrailers.com)

### Additional Contact Information

For your convenience, the following list of internet contacts of our primary vendors can be referred to if you require additional information about their specific components.

Axles & Running Gear	Dexter Axles	<a href="http://www.dexteraxle.com">www.dexteraxle.com</a>
Couplers-Gooseneck	B&W	<a href="http://www.bwtrailerhitches.com">www.bwtrailerhitches.com</a>
Bumper Hitch	Bulldog	<a href="http://www.bulldogproducts.net">www.bulldogproducts.net</a>
Electric/Hydraulics Jacks	Bulldog	<a href="http://www.bulldogproducts.net">www.bulldogproducts.net</a>
	Equalizer	<a href="http://www.equalizersystems.com">www.equalizersystems.com</a>
Glide Room Mechanism	HWH	<a href="http://www.hwhcorp.com">www.hwhcorp.com</a>
	Liftco	<a href="http://www.liftcoproducts.com">www.liftcoproducts.com</a>
Manual Jacks	Bulldog	<a href="http://www.bulldogproducts.net">www.bulldogproducts.net</a>

## Introduction

Portions of this user's manual were used with the expressed authority of Dexter Axle, but Dexter Axle is not responsible for the accuracy of the information contained herein.

## 2 GENERAL SAFETY INFORMATION

### 2.1 SAFETY ALERT SYMBOLS AND SIGNAL WORDS

An Owner's Manual that provides general trailer information cannot cover all of the specific details necessary for the proper combination of every trailer, tow vehicle and hitch. Therefore, you must read, understand and follow the instructions given by the tow vehicle and trailer hitch manufacturers, as well as the instructions in this manual.

Our trailers are built with components produced by various manufacturers. Some of these items have separate instruction manuals. Where this manual indicates that you should read another manual, and you do not have that manual, call Cimarron Trailers, Inc. at 405-222-4800 for a free copy.

The safety information in this manual is denoted by the safety alert symbol: 

The level of risk is indicated by the following signal words.

**DANGER** – Immediate hazards which **WILL** result in severe personal injury or death if the warning is ignored.

#### **WARNING**

**WARNING** – Hazards or unsafe practices which **COULD** result in severe personal injury or death if the warning is ignored.

#### **CAUTION**

**CAUTION** – Hazards or unsafe practices which could result in minor or moderate injury if the warning is ignored.

## General Safety Information

### *NOTICE*

**NOTICE – Practices that could result in damage to the trailer or other property.**

## **2.2 MAJOR HAZARDS**

Loss of control of the trailer or trailer/tow vehicle combination can result in death or serious injury. The most common causes for loss of control of the trailer are:

- Improper sizing the trailer for the tow vehicle, or vice versa.
- Excessive Speed: Driving too fast for the conditions.
- Failure to adjust driving behavior when towing a trailer.
- Overloading and/or improper weight distribution.
- Improper or mis-coupling of the trailer to the hitch.
- Improper braking and steering under sway conditions.
- Not maintaining proper tire pressure.
- Not keeping lug nuts tight.

### **2.2.1 Improper Sizing of the Trailer to the Tow Vehicle**

Trailers that weigh too much for the towing vehicle can cause stability problems, which can lead to death or serious injury. Furthermore, the additional strain put on the engine and drive-train may lead to serious tow vehicle maintenance problems. For these reasons the maximum towing capacity of your towing vehicle should not be exceeded. The towing capacity of your tow vehicle, in terms of maximum Gross Trailer Weight (GTW) and maximum Gross Combined Weight Rating (GCWR) can be found in the tow vehicles Owner's Manual.

## General Safety Information

Use of a hitch with a load rating less than the load rating of the trailer can result in loss of control and may lead to death or serious injury.

Use of a tow vehicle with a towing capacity less than the load rating of the trailer can result in loss of control, and may lead to death or serious injury.

Be sure your hitch and tow vehicle are rated for the Gross Vehicle Weight Rating (GVWR) of your trailer.

### **2.2.2 Driving Too Fast**

If you drive too fast, the trailer is more likely to sway, thus increasing the possibility for loss of control. Also your tires may overheat, thus increasing the possibility of a blowout.

### **WARNING**

Driving too fast for conditions can result in loss of control and cause death or serious injury.

Decrease your speed as road, weather and lighting conditions deteriorate.

### **2.2.3 Adjust Driving Behavior When Towing a Trailer**

When towing a trailer, you will have decreased acceleration, increased stopping distance, and increased turning radius (which means you must make wider turns to keep from hitting curbs, vehicles, and anything else that is on the inside corner). Furthermore, the trailer will change the handling characteristics of your towing vehicle, making it more sensitive to steering inputs and more likely to be pushed around in windy conditions or when being passed by large vehicles. In addition, you will need a longer distance to pass, due to slower acceleration and increased length. With these caveats in mind:

## General Safety Information

- Be alert for slippery conditions. You are more likely to be affected by slippery road surfaces when driving a tow vehicle with a trailer, than driving a tow vehicle without a trailer.
- Anticipate the trailer “swaying.” Swaying can be caused by excessive steering, wind gusts, roadway edges, or by the trailer reaction to the pressure wave created by passing trucks and busses.
- When encountering trailer sway, take your foot off the gas, and steer as little as possible in order to stay on the road. Use small “trim-like” steering adjustments. Do not attempt to steer out of the sway; you’ll only make it worse. Also, do not apply the tow vehicle brakes to correct trailer swaying. On the other hand, application of the trailer brakes alone will tend to straighten out the combination, especially when going downhill.
- Check rearview mirrors frequently to observe the trailer and traffic.
- Use lower gear when driving down steep or long grades. Use the engine and transmission as a brake. Do not ride the brakes, as they can overheat and become ineffective.
- Be aware of your trailer height, especially when approaching bridges, roofed areas and around trees.

### **2.2.4 Improper Loading**

The total weight of the load you put in or on the trailer, plus the empty weight of the trailer itself, must not exceed the trailer's Gross Vehicle Weight Rating (GVWR). If you do not know the empty weight of the trailer plus the cargo weight, you must weigh the loaded trailer at a commercial scale. In addition, you must distribute the load in the trailer such that the load on any axle does not exceed the Gross Axle Weight Rating (GAWR). If your trailer is equipped with a Tire & Loading Information Placard mounted next to the Certification / VIN label, the cargo capacity weight stated on that placard is only a close estimate. The GVWR and GAWR's are listed on the Certification / VIN label mounted on the front left side of the trailer.

## General Safety Information

### **WARNING**

An overloaded trailer can result in loss of control of the trailer, leading to death or serious injury.

Do not exceed the trailer Gross Vehicle Weight Rating (GVWR) or an axle Gross Axle Weight Rating (GAWR).

Do not load a trailer so that the weight on any tire exceeds its rating.

### **2.2.5 Unsafe Load Distribution**

Improper front / rear load distribution can lead to poor trailer sway stability or poor tow vehicle handling. Poor trailer sway stability results from tongue weights that are too low, and poor tow vehicle stability results from tongue weights that are too high.

In the following table, the second column shows the RULE OF THUMB percentage of total weight of the trailer plus its cargo (Gross Trailer Weight, or “GTW”) that should appear on the tongue of the trailer. For example, a trailer with a gooseneck hitch, with a loaded weight of 12,000 pounds, should have 20-30% of 12,000 pounds (2400-3600 lbs.) on the gooseneck. After loading, be sure to check that none of the axles are overloaded.

NOTE: Due to custom manufacturing requirements and changes, the above rule of thumb may vary greatly on highly customized models. Check with Cimarron Trailers at 405/222-4800 for tongue weights on specific trailers.

Tongue Weight as a Percentage of Loaded Trailer Weight	
Type of Hitch	Percentage
Ball Hitch (or Bumper Hitch)	10-20%
Gooseneck Hitch	20-30%

Uneven left / right load distribution can cause tire, wheel, axle or structural failure. Be sure your trailer is evenly loaded left / right.

## General Safety Information

Towing stability also depends on keeping the center of gravity as low as possible.

### **WARNING**

Improper tongue weight (load distribution) can result in loss of control of the trailer, leading to death or serious injury.

Make certain that tongue weight is within the allowable range.

Be sure to:

- Distribute the load front-to-rear to provide proper tongue weight (see chart);
- Distribute the load evenly, right and left, to avoid tire overload; and
- Keep the center of gravity low.

### **2.2.6 Trailer Not Properly Coupled to the Hitch**

It is critical that the trailer be securely coupled to the hitch ball, and that the safety chains and emergency breakaway brake lanyard are correctly attached. Uncoupling may result in death or serious injury to you and to others.

### **WARNING**

Proper selection and condition of the coupler and hitch are essential to safely towing your trailer. A loss of coupling may result in death or serious injury.

- Be sure the hitch load rating is equal to or greater than the load rating of the coupler.
- Be sure the hitch size matches the coupler size.
- Observe the hitch for wear, corrosion and cracks before coupling. Replace worn, corroded or cracked hitch components before coupling the trailer to the tow vehicle.
- Be sure the hitch components are tight before coupling the trailer to the tow vehicle.

## General Safety Information

### WARNING

An improperly coupled trailer can result in death or serious injury.

Do not move the trailer until:

- The coupler is secured and locked to hitch;
- The safety chains are secured to the tow vehicle; and
- The trailer jack(s) are fully retracted.

Do not tow the trailer on the road until:

- Tires and wheels are checked;
- The trailer brakes are checked;
- The breakaway switch is connected to the tow vehicle;
- The load is secured to the trailer; and
- The trailer lights are connected and checked.

### **2.2.7 Proper Use of Safety Chains**

If your trailer comes loose from the hitch for any reason, we have provided safety chains so that control of the trailer can still be maintained.

### WARNING

Improper rigging of the safety chains can result in loss of control of the trailer and tow vehicle, leading to death or serious injury, if the trailer uncouples from the tow vehicle.

- Fasten chains to frame of tow vehicle. Do not fasten chains to any part of the hitch unless the hitch has holes or loops specifically for that purpose.
- Cross chains underneath hitch and coupler with enough slack to permit turning and to hold tongue up, if the trailer comes loose.

### **2.2.8 Proper Connection of Breakaway Brake**

If equipped with brakes, your trailer will be equipped with a breakaway brake system that can apply the brakes on your trailer if your trailer comes loose from the hitch ball for any reason. You will have a separate set of

## General Safety Information

instructions for the breakaway brake if your trailer is so equipped. The breakaway brake system, including battery, must be in good condition and properly rigged to be effective.

### **WARNING**

An ineffective or inoperative breakaway brake system can result in a runaway trailer, leading to death or serious injury if the coupler or hitch fails.

The breakaway lanyard must be connected to the tow vehicle, and NOT to any part of the hitch.

Before towing the trailer, test the function of the breakaway brake system. If the breakaway brake system is not working, do not tow the trailer. Have it serviced or repaired.

### **2.2.9 Matching Trailer and Hitch**

Use of a hitch with a load rating less than the load rating of the trailer can result in loss of control and may lead to death or serious injury.

Use of a tow vehicle with a towing capacity less than the load rating of the trailer can result in loss of control, and may lead to death or serious injury.

Be sure your hitch and tow vehicle are rated for the Gross Vehicle Weight Rating (GVWR) of your trailer.

### **2.2.10 Worn Tires, Loose Wheels and Lug Nuts**

Just as with your tow vehicle the trailer tires and wheels are important safety items. Therefore, it is essential to inspect the trailer tires before each tow.

If a tire has a bald spot, bulge, cut, cracks, or is showing any cords, replace the tire before towing. If a tire has uneven tread wear, take the trailer to a dealer service center for diagnosis. Uneven tread wear can be caused by tire imbalance, axle misalignment or incorrect inflation.

## General Safety Information

Tires with too little tread will not provide adequate frictional forces on wet roadways and can result in loss of control, leading to death or serious injury.

Improper tire pressure causes increased tire wear and may reduce trailer stability, which can result in a tire blowout or possible loss of control. Therefore, before each tow you must also check the tire pressure. Remember, the proper tire pressure is listed on the Certification / VIN label, and should be checked when tires are cold. Allow 3 hours cool-down after driving as much as 1 mile at 40 mph before checking tire pressure.

The proper inflation pressure for tires is listed in Section 9.2.9 in the "Inspection And Service Instructions" chapter of this manual. Use an air gauge of proper capacity to check tire inflation pressure.

### WARNING

Improper tire pressure can result in a blowout and loss of control, which can lead to death or serious injury.

Be sure tires are inflated to pressure indicated Certification / VIN label before towing trailer.

The tightness of the lug nuts is very important in keeping the wheels properly seated to the hub. Before each tow, check to make sure the lug nuts are tight.

### WARNING

Metal creep between the wheel rim and lug nuts will cause rim to loosen and could result in a wheel coming off, leading to death or serious injury.

Tighten lug nuts before each tow.

The proper tightness (torque) for lug nuts is listed in Section 9.2.12 in the "Inspection and Service Instructions" chapter of this manual. Use a calibrated torque wrench to tighten the lug nuts.

Lug nuts are also prone to loosen after first being assembled. When driving a new trailer (or after wheels have been remounted), check to make

## General Safety Information

sure they are tight after the **first** 10, 25 and 50 miles of driving and before each tow thereafter.

Failure to perform this check can result in a wheel separating from the trailer and a crash, leading to death or serious injury.

### WARNING

Lug nuts are prone to loosen after initial installation, which can lead to death or serious injury.

Check lug nuts for tightness on a new trailer or when wheel(s) have been remounted after the first 10, 25 and 50 miles of driving.

### WARNING

Improper lug nut torque can cause a wheel separating from the trailer, leading to death or serious injury.

Be sure lug nuts are tight before each tow.

### **2.2.11 Shifting Cargo**

Since the trailer “ride” can be bumpy and rough, you must secure your cargo so that it does not shift while the trailer is being towed.

### WARNING

Shifting cargo can result in loss of control of the trailer, and can lead to death or serious injury.

Tie down all loads with proper sized fasteners, ropes, straps, etc.

## General Safety Information

### WARNING

If the door opens, your cargo may be ejected onto the road, resulting in death or serious injury to other drivers.

Always secure the door latch after closing.

### **2.2.12 Inappropriate Cargo**

Your trailer may be designed for specific cargo, for example, only for horses. If your trailer is designed for specific cargo, only carry that cargo in the trailer. Your trailer must not be used to carry certain items, such as people, containers of hazardous substances or containers of flammable substances. A trailer not designed with living quarters should only be used for transportation of its intended cargo.

You can die or be brain damaged by Carbon Monoxide.

Do not operate a portable generator, portable grill, portable heater, portable lantern or portable stove inside the trailer.

### WARNING

Do not transport people inside the trailer, even if it has living quarters. The transport of people puts their lives at risk and may be illegal.

### WARNING

Do not sleep in a trailer not equipped with living quarters.

A trailer not designed with living quarters should only be used for transportation of its intended cargo.

## General Safety Information

### WARNING

Do not transport flammable, explosive, poisonous or other dangerous materials in your trailer.

Exceptions:

- Fuel in the tanks of vehicles that are being towed;
- Fuel stored in proper containers used in trailer living quarters for cooking;
- Fuel stored in the tank of an on-board generator.

### **2.2.13 Inoperable Brakes, Lights or Mirrors**

Be sure that the electric brakes and all of the lights on your trailer are functioning properly before towing your trailer.

If your trailer has electric brakes, your tow vehicle will have an electric brake controller that sends power to the trailer brakes. Before towing the trailer on the road, you must operate the brake controller while trying to pull the trailer in order to confirm that the electric brakes operate.

### WARNING

Improper electrical connection between the tow vehicle and the trailer will result in inoperable lights and electric brakes, and can lead to collision.

Before each tow:

- Check that the taillights, brake lights and turn signals work.
- Check that the electric brakes work by operating the brake controller inside the tow vehicle.

Standard mirrors usually do not provide adequate visibility for viewing traffic to the sides and rear a towed trailer. You must provide mirrors that allow you to safely observe approaching traffic.

## General Safety Information

### **2.2.14 Hazards From Modifying Your Trailer**

Essential safety items can be damaged by altering your trailer. Even simply driving a nail or screw to hang something can damage an electrical circuit, LP gas line or other feature of the trailer.

Before making any alteration to your trailer, contact your dealer or Cimarron Trailers, Inc. at 405-222-4800 and describe the alteration you are contemplating. Alteration of the trailer structure or modification of mechanical, electrical, plumbing, heating or other systems on your trailer must be performed only by qualified technicians who are familiar with the system as installed on your trailer.

### **2.2.15 Hazards to Horses (Horse Trailer)**

Before hauling a horse, you must be aware of its temperament.

The layout of a horse trailer is designed to safely contain your horse. The trailer is equipped with stall dividers and tie rings to secure the horse, and has a rubber floor mat to keep shod horses from slipping on the metal underfloor. Restraining a horse without using a combination of a tie-strap and stall dividers may result in serious injury or death to the horse.

Before loading your horse, inspect the interior of the horse trailer to insure that no hazards are present. Read the “Loading the Horse Trailer” Section 5.3 of this manual for specific instructions regarding trailering of horses.

## **WARNING**

When a horse is frightened, it is capable of inflicting serious injury or death to a human handler.

Know your horse's temperament before attempting to trailer it.

Handling a horse that is not trailer-acclimated may result in injury or death, or damage to your trailer.

Do not haul an unbroken horse in this trailer.

Horses must have a halter.

## General Safety Information

### CAUTION

Failure to secure a horse using a tie strap may result in its serious injury or death.

### CAUTION

The trailer interior may contain hazards to a horse that can result in its serious injury or death.

Before loading a horse, inspect the trailer interior and adjust or repair all loose and protruding features such as handles, loose or broken parts of the trailer, etc.

Before towing trailer:

- Lock all stall dividers.
- Be sure all saddles, tack and equipment, as well as horse(s), are prevented from being thrown about.

### CAUTION

Hauling a horse in a livestock trailer may result in its serious injury or death.

Do not carry a horse in a livestock trailer. Use a trailer designed to carry horses.

### **2.2.16 Hazards to Livestock (Livestock Trailer)**

A livestock trailer is designed for the safe transport of livestock, other than horses. It is not equipped for hauling horses.

Before loading your livestock, inspect the interior of the livestock trailer to insure that no hazards are present. Read section 5.4, “Loading Livestock (Livestock Trailer)” for specific instructions regarding trailering of livestock other than horses.

## General Safety Information

### WARNING

Large animals are capable of inflicting serious injury or death to a human handler.

Know your animals' temperament before attempting to trailer them.

### CAUTION

Hauling a horse in a livestock trailer may result in its serious injury or death.

Do not carry a horse in a livestock trailer. Use a trailer designed to carry horses.

#### **2.2.17 Hazards from Accessories**

The “Accessories” section of this manual contains some information about certain optional accessories that may be on your trailer. Read and follow all of these instructions before operating the accessories.



## General Safety Information

### **WARNING**

To protect you and others against death or serious injury, all of the labels must be on the trailer and must be legible. See figure 2-1.

If any of these labels are missing or cannot be read, call Cimarron Trailers, Inc. at 405-222-4800 for free replacement labels.

You will need to provide us with the number shown at the bottom of the label(s) in order for us to send the correct one(s).

### **2.2.19 Trailer Towing Guide**

Driving a vehicle with a trailer in tow is vastly different from driving the same vehicle without a trailer in tow. Acceleration, maneuverability and braking are all diminished with a trailer in tow. It takes longer to get up to speed, you need more room to turn and pass, and more distance to stop when towing a trailer. You will need to spend time adjusting to the different feel and maneuverability of the tow vehicle with a loaded trailer. Because of the significant differences in all aspects of maneuverability when towing a trailer, the hazards and risks of injury are also much greater than when driving without a trailer. You are responsible for keeping your vehicle and trailer in control, and for all the damage that is caused if you lose control of your vehicle and trailer.

As you did when learning to drive an automobile, find an open area with little or no traffic for your first practice trailering. Of course, before you start towing the trailer, you must follow all of the instructions for inspection, testing, loading and coupling. Also, before you start towing, adjust the mirrors so you can see the trailer as well as the area to the rear of it.

Drive slowly at first, 5 mph or so, and turn the wheel to get the feel of how the tow vehicle and trailer combination responds. Next, make some right and left hand turns. Watch in your side mirrors to see how the trailer follows the tow vehicle. Turning with a trailer attached requires more room.

Stop the rig a few times from speeds no greater than 10 mph. If your trailer is equipped with brakes, try using different combinations of trailer/electric brake and tow vehicle brake. Note the effect that the trailer

## General Safety Information

brakes have when they are the only brakes used. When properly adjusted, the trailer brakes will come on just before the tow vehicle brakes.

It will take practice to learn how to back up a tow vehicle with a trailer attached. Take it slow. Before backing up, get out of the tow vehicle and look behind the trailer to make sure that there are no obstacles. Some drivers place their hands at the bottom of the steering wheel, and while the tow vehicle is in reverse, “think” of the hands as being on the top of the wheel. When the hands move to the right (counter-clockwise, as you would do to turn the tow vehicle to the left when moving forward), the rear of the trailer moves to the right. Conversely, rotating the steering wheel clockwise with your hands at the bottom of the wheel will move the rear of the trailer to the left, while backing up. If you are towing a bumper hitch rig, be careful not to allow the trailer to turn too much, because it will hit the rear of the tow vehicle. To straighten the rig, either pull forward, or turn the steering wheel in the opposite direction.

### Safe Trailer Towing Guidelines

- Recheck the gates and dividers to make sure the horses or livestock cannot shift or move during towing.
- Before towing, check coupling, safety chain, safety brake, tires, wheels and lights.
- Check the lug nuts or bolts for tightness.
- Check coupler tightness after towing 50 miles.
- Adjust the brake controller to engage the trailer brakes before the tow vehicle brakes.
- Use your mirrors to verify that you have room to change lanes or pull into traffic.
- Use your turn signals well in advance.
- Allow plenty of stopping space for your trailer and tow vehicle.
- Do not drive so fast that the trailer begins to sway due to speed. Generally, never drive faster than 60 m.p.h.
- Allow plenty of room for passing. A rule of thumb is that the passing distance with a trailer is 4 times the passing distance without a trailer.
- Shift your automatic transmission into a lower gear for city driving.
- Use lower gears for climbing and descending grades.

## General Safety Information

- Do not ride the brakes while descending grades, they may get so hot that they stop working. Then you will potentially have a runaway tow vehicle and trailer.
- Slow down for bumps in the road. Take your foot off the brake when crossing the bump.
- Do not brake while in a curve unless absolutely necessary. Instead, slow down before you enter the curve.
- Do not apply the tow vehicle brakes to correct extreme trailer swaying. Instead, lightly apply the trailer brakes with the hand controller.
- Make regular stops, about once each hour.
- Confirm that:

The coupler is secure to the hitch and is locked,

Electrical connectors are made,

There is appropriate slack in the safety chains,

There is appropriate slack in the breakaway switch pullpin lanyard,

The tires are not visibly low on pressure, and

The cargo is secure and in good condition.

### **2.2.20 Reporting Safety Defects**

If you believe that your vehicle has a defect that could cause a crash or could cause injury or death, you should immediately inform the National Highway Traffic Safety Administration (NHTSA) in addition to notifying us.

If NHTSA receives similar complaints, it may open an investigation, and if it finds that a safety defect exists in a group of vehicles, it may order a recall and remedy campaign. However, NHTSA cannot become involved in individual problems between you, your dealer, or us.

To contact NHTSA, you may either call the Vehicle Safety Hotline toll-free at 1-888-327-4236 (TTY: 1-800-424-9153), go to

<http://www.nhtsa.gov>; or write to: NHTSA Headquarters, 1200 New Jersey Avenue, SE, West Building, Washington, DC 20590. You can also obtain other information about motor vehicle safety from <http://www.nhtsa.gov>.

Call 405-222-4800 to reach Cimarron Trailers, Inc.

## 3 TIRE SAFETY INFORMATION

This portion of the User's Manual contains tire safety information as required by 49 CFR 575.6.

Section 3.1 contains "Trailer Tire Information"

Section 3.2 contains "Steps for Determining Correct Load Limit - Trailer".

Section 3.3 contains "Steps for Determining Correct Load Limit – Tow Vehicle".

Section 3.4 contains a Glossary of Tire Terminology, including "cold inflation pressure", "maximum inflation pressure", "recommended inflation pressure", and other non-technical terms.

Section 3.5 contains information from the NHTSA brochure entitled "Tire Safety – Everything Rides On It".

This brochure, as well as the preceding subsections, describe the following items;

- Tire labeling, including a description and explanation of each marking on the tires, and information about the DOT Tire Identification Number (TIN).
- Recommended tire inflation pressure, including a description and explanation of:

Cold inflation pressure.

Vehicle Placard and location on the vehicle.

Adverse safety consequences of under inflation (including tire failure).

Measuring and adjusting air pressure for proper inflation.

- Tire Care, including maintenance and safety practices.
- Vehicle load limits, including a description and explanation of the following items:

Locating and understanding the load limit information, total load capacity, and cargo capacity.

Calculating total and cargo capacities with varying seating configurations including quantitative examples showing / illustrating how the vehicles cargo and luggage capacity decreases as combined number and size of occupants' increases. This item is also discussed in Section 3.

# Tire Safety Information

Determining compatibility of tire and vehicle load capabilities.  
Adverse safety consequences of overloading on handling and stopping on tires.

## **3.1 TRAILER TIRE INFORMATION**

Trailer tires may be worn out even though they still have plenty of tread left. This is because trailer tires have to carry a lot of weight all the time, even when not in use. It is actually better for the tire to be rolling down the road than to be idle. During use, the tire releases lubricants that are beneficial to tire life. Using the trailer tires often also helps prevent flat spots from developing.

The main cause of tire failure is improper inflation. Check the cold tire inflation pressures at least once a week for proper inflation levels. “Cold” means that the tires are at the same temperature as the surrounding air, such as when the vehicle has been parked overnight. Wheel and tire manufacturers recommend adjusting the air pressure to the trailer manufacturers recommended cold inflation pressure, in pounds per square inch (PSI) stated on the vehicle’s Federal Certification Label or Tire Placard when the trailer is loaded to its gross vehicle weight rating (GVWR). If the tires are inflated to less than the recommended inflation level or the GVWR of the trailer is exceeded, the load carrying capacity of the tire could be dramatically affected. If the tires are inflated more than the recommended inflation level, handling characteristics of the tow vehicle/trailer combination could be affected. Refer to the owner’s manual or talk to your dealer or vehicle manufacturer if you have any questions regarding proper inflation practices.

Tires can lose air over a period of time. In fact, tires can lose 1 to 3 PSI per month. This is because molecules of air, under pressure, weave their way from the inside of the tire, through the rubber, to the outside. A drop in tire pressure could cause the tire to become overloaded, leading to excessive heat build up. If a trailer tire is under-inflated, even for a short period of time, the tire could suffer internal damage.

High speed towing in hot conditions degrades trailer tires significantly. As heat builds up during driving, the tire’s internal structure starts to

## Tire Safety Information

breakdown, compromising the strength of the tire. It is recommended to drive at moderate speeds.

Statistics indicate the average life of a trailer tire is about five years under normal use and maintenance conditions. After three years, replacing the trailer tires with new ones should be considered, even if the tires have adequate tread depth. Some experts claim that after five years, trailer tires are considered worn out and should be replaced, even if they have had minimal or no use. This is such a general statement that it may not apply in all cases. It is best to have your tires inspected by a tire supplier to determine if your tires need to be replaced.

If you are storing your trailer for an extended period, make sure the tires are fully inflated to the maximum rated pressure and that you store them in a cool, dry place, such as a garage. Use tire covers to protect the trailer tires from the harsh effects of the sun.

### **3.2 STEPS FOR DETERMINING CORRECT LOAD LIMIT – TRAILER**

Determining the load limits of a trailer includes more than understanding the load limits of the tires alone. On all trailers there is a Federal Certification / VIN label that is located on the forward half of the left (road) side of the unit. This certification/VIN label will indicate the trailer's Gross Vehicle Weight Rating (GVWR). This is the most weight the fully loaded trailer can weigh. It will also provide the Gross Axle Weight Rating (GAWR). This is the most a particular axle can weigh. If there are multiple axles, the GAWR of each axle will be provided.

If your trailer has a GVWR of 10,000 pounds or less, there is a vehicle placard located in the same location as the certification label described above. This placard provides tire and loading information. In addition, this placard will show a statement regarding maximum cargo capacity. Cargo can be added to the trailer, up to the maximum weight specified on the placard. The combined weight of the cargo is provided as a single number. In any case, remember: the total weight of a fully loaded trailer can not exceed the stated GVWR.

For trailers with living quarters installed, the weight of water and propane also need to be considered. The weight of fully filled propane containers is

## Tire Safety Information

considered part of the weight of the trailer before it is loaded with cargo, and is not considered part of the disposable cargo load. Water however, is a disposable cargo weight and is treated as such. If there is a fresh water storage tank of 100 gallons, this tank when filled would weigh about 800 pounds. If more cargo is being transported, water can be off-loaded to keep the total amount of cargo added to the vehicle within the limits of the GVWR so as not to overload the vehicle. Understanding this flexibility will allow you, the owner, to make choices that fit your travel needs.

When loading your cargo, be sure it is distributed evenly to prevent overloading front to back and side to side. Heavy items should be placed low and as close to the axle positions as reasonable. Too many items on one side may overload a tire. The best way to know the actual weight of the vehicle is to weigh it at a public scale. Talk to your dealer to discuss the weighing methods needed to capture the various weights related to the trailer. This would include the weight empty or unloaded, weights per axle, wheel, hitch or king-pin, and total weight.

Excessive loads and/or underinflation cause tire overloading and, as a result, abnormal tire flexing occurs. This situation can generate an excessive amount of heat within the tire. Excessive heat may lead to tire failure. It is the air pressure that enables a tire to support the load, so proper inflation is critical. The proper air pressure may be found on the Certification / VIN label and/or on the Tire Placard. This value should never exceed the maximum cold inflation pressure stamped on the tire.

## Tire Safety Information

### 3.2.1 Trailers 10,000 Pounds GVWR or Less

TIRE AND LOADING INFORMATION		
The weight of cargo should never exceed _____ kg. or _____ lbs.		
TIRE	SIZE	COLD TIRE PRESSURE
SPARE		
SEE OWNER'S MANUAL FOR ADDITIONAL INFORMATION		

*Tire Information Placard – Figure 3-1*

1. Locate the statement, “The weight of cargo should never exceed XXX kg or XXX lbs.,” on your vehicle’s placard. See figure 3-1.
2. This figure equals the available amount of cargo and luggage load capacity.
3. Determine the combined weight of luggage and cargo being loaded on the vehicle. That weight may not safely exceed the available cargo and luggage load capacity.

The trailer’s placard refers to the Tire Information Placard attached adjacent to or near the trailer’s VIN (Certification) label at the left front of the trailer.

### 3.2.2 Trailers Over 10,000 Pounds GVWR

**Note:** These trailers are not required to have a tire information placard on the trailer and may not have one installed

1. Determine the empty weight of your trailer by weighing the trailer using a public scale or other means. This step does not have to be repeated.
2. Locate the GVWR (Gross Vehicle Weight Rating) of the trailer on your trailer’s VIN (Certification) label.

## Tire Safety Information

3. Subtract the empty weight of your trailer from the GVWR stated on the VIN label. That weight is the maximum available cargo capacity of the trailer and may not be safely exceeded.

### **3.3 STEPS FOR DETERMINING CORRECT LOAD LIMIT – TOW VEHICLE**

1. Locate the statement, “The combined weight of occupants and cargo should never exceed XXX lbs.,” on your vehicle’s placard.
2. Determine the combined weight of the driver and passengers who will be riding in your vehicle.
3. Subtract the combined weight of the driver and passengers from XXX kilograms or XXX pounds.
4. The resulting figure equals the available amount of cargo and luggage capacity. For example, if the “XXX” amount equals 1400 lbs. and there will be five 150 lb. passengers in your vehicle, the amount of available cargo and luggage capacity is 650 lbs.  $(1400 - 750 (5 \times 150) = 650 \text{ lbs.})$ .
5. Determine the combined weight of luggage and cargo being loaded on the vehicle. That weight may not safely exceed the available cargo and luggage capacity calculated in Step # 4.
6. If your vehicle will be towing a trailer, load from your trailer will be transferred to your vehicle. Consult the tow vehicle’s manual to determine how this weight transfer reduces the available cargo and luggage capacity of your vehicle.

### **3.4 GLOSSARY OF TIRE TERMINOLOGY**

**Accessory weight** The combined weight (in excess of those standard items which may be replaced) of automatic transmission, power steering, power brakes, power windows, power seats, radio and heater, to the extent that these items are available as factory-installed equipment (whether installed or not).

**Bead** The part of the tire that is made of steel wires, wrapped or reinforced by ply cords and that is shaped to fit the rim.

**Bead separation** This is the breakdown of the bond between components in the bead.

## Tire Safety Information

**Bias ply tire** A pneumatic tire in which the ply cords that extend to the beads are laid at alternate angles substantially less than 90 degrees to the centerline of the tread.

**Carcass** The tire structure, except tread and sidewall rubber which, when inflated, bears the load.

**Chunking** The breaking away of pieces of the tread or sidewall.

**Cold inflation pressure** The pressure in the tire before you drive.

**Cord** The strands forming the plies in the tire.

**Cord separation** The parting of cords from adjacent rubber compounds.

**Cracking** Any parting within the tread, sidewall, or inner liner of the tire extending to cord material.

**CT** A pneumatic tire with an inverted flange tire and rim system in which the rim is designed with rim flanges pointed radially inward and the tire is designed to fit on the underside of the rim in a manner that encloses the rim flanges inside the air cavity of the tire.

**Curb weight** The weight of a motor vehicle with standard equipment including the maximum capacity of fuel, oil, and coolant, and, if so equipped, air conditioning and additional weight optional engine.

**Extra load tire** A tire designed to operate at higher loads and at higher inflation pressures than the corresponding standard tire.

**Groove** The space between two adjacent tread ribs.

**Gross Axle Weight Rating** The maximum weight that any axle can support, as published on the Certification / VIN label on the front left side of the trailer. Actual weight determined by weighing each axle on a public scale, with the trailer attached to the towing vehicle.

**Gross Vehicle Weight Rating** The maximum weight of the fully loaded trailer, as published on the Certification / VIN label. Actual weight

## Tire Safety Information

determined by weighing trailer on a public scale, without being attached to the towing vehicle.

**Hitch Weight** The downward force exerted on the hitch ball by the trailer coupler.

**Innerliner** The layer(s) forming the inside surface of a tubeless tire that contains the inflating medium within the tire.

**Innerliner separation** The parting of the innerliner from cord material in the carcass.

**Intended outboard sidewall** The sidewall that contains a white-wall, bears white lettering or bears manufacturer, brand, and/or model name molding that is higher or deeper than the same molding on the other sidewall of the tire or the outward facing sidewall of an asymmetrical tire that has a particular side that must always face outward when mounted on a vehicle.

**Light truck (LT) tire** A tire designated by its manufacturer as primarily intended for use on lightweight trucks or multipurpose passenger vehicles.

**Load rating** The maximum load that a tire is rated to carry for a given inflation pressure.

**Maximum load rating** The load rating for a tire at the maximum permissible inflation pressure for that tire.

**Maximum permissible inflation pressure** The maximum cold inflation pressure to which a tire may be inflated.

**Maximum loaded vehicle weight** The sum of curb weight, accessory weight, vehicle capacity weight, and production options weight.

**Measuring rim** The rim on which a tire is fitted for physical dimension requirements.

**Non-pneumatic rim** A mechanical device which, when a non-pneumatic tire assembly incorporates a wheel, supports the tire, and attaches, either integrally or separably, to the wheel center member and upon which the tire is attached.

## Tire Safety Information

**Non-pneumatic spare tire assembly** A non-pneumatic tire assembly intended for temporary use in place of one of the pneumatic tires and rims that are fitted to a passenger car in compliance with the requirements of this standard.

**Non-pneumatic tire** A mechanical device which transmits, either directly or through a wheel or wheel center member, the vertical load and tractive forces from the roadway to the vehicle, generates the tractive forces that provide the directional control of the vehicle and does not rely on the containment of any gas or fluid for providing those functions.

**Non-pneumatic tire assembly** A non-pneumatic tire, alone or in combination with a wheel or wheel center member, which can be mounted on a vehicle.

**Normal occupant weight** This means 68 kilograms (150 lbs.) times the number of occupants specified in the second column of Table I of 49 CFR 571.110.

**Occupant distribution** The distribution of occupants in a vehicle as specified in the third column of Table I of 49 CFR 571.110.

**Open splice** Any parting at any junction of tread, sidewall, or innerliner that extends to cord material.

**Outer diameter** The overall diameter of an inflated new tire.

**Overall width** The linear distance between the exteriors of the sidewalls of an inflated tire, including elevations due to labeling, decorations, or protective bands or ribs.

**Pin Weight** The downward force applied to the 5<sup>th</sup> wheel or gooseneck ball, by the trailer kingpin or gooseneck coupler.

**Ply** A layer of rubber-coated parallel cords.

**Ply separation** A parting of rubber compound between adjacent plies.

## Tire Safety Information

**Pneumatic tire** A mechanical device made of rubber, chemicals, fabric and steel or other materials, that, when mounted on an automotive wheel, provides the traction and contains the gas or fluid that sustains the load.

**Production options weight** The combined weight of those installed regular production options weighing over 2.3 kilograms (5 lbs.) in excess of those standard items which they replace, not previously considered in curb weight or accessory weight, including heavy duty brakes, ride levelers, roof rack, heavy duty battery, and special trim.

**Radial ply tire** A pneumatic tire in which the ply cords that extend to the beads are laid at substantially 90 degrees to the centerline of the tread.

**Recommended inflation pressure** This is the inflation pressure provided by the vehicle manufacturer on the Tire Information label and on the Certification / VIN tag.

**Reinforced tire** A tire designed to operate at higher loads and at higher inflation pressures than the corresponding standard tire.

**Rim** A metal support for a tire or a tire and tube assembly upon which the tire beads are seated.

**Rim diameter** This means the nominal diameter of the bead seat.

**Rim size designation** This means the rim diameter and width.

**Rim type designation** This means the industry of manufacturers designation for a rim by style or code.

**Rim width** This means the nominal distance between rim flanges.

**Section width** The linear distance between the exteriors of the sidewalls of an inflated tire, excluding elevations due to labeling, decoration, or protective bands.

**Sidewall** That portion of a tire between the tread and bead.

**Sidewall separation** The parting of the rubber compound from the cord material in the sidewall.

## Tire Safety Information

**Test rim** The rim on which a tire is fitted for testing, and may be any rim listed as appropriate for use with that tire.

**Tread** That portion of a tire that comes into contact with the road.

**Tread rib** A tread section running circumferentially around a tire.

**Tread separation** Pulling away of the tread from the tire carcass.

**Treadwear indicators (TWI)** The projections within the principal grooves designed to give a visual indication of the degrees of wear of the tread.

**Vehicle capacity weight** The rated cargo and luggage load plus 68 kilograms (150 lbs.) times the vehicle's designated seating capacity.

**Vehicle maximum load on the tire** The load on an individual tire that is determined by distributing to each axle its share of the maximum loaded vehicle weight and dividing by two.

**Vehicle normal load on the tire** The load on an individual tire that is determined by distributing to each axle its share of the curb weight, accessory weight, and normal occupant weight (distributed in accordance with Table I of CRF 49 571.110) and dividing by 2.

**Weather side** The surface area of the rim not covered by the inflated tire.

**Wheel center member** In the case of a non-pneumatic tire assembly incorporating a wheel, a mechanical device which attaches, either integrally or separably, to the non-pneumatic rim and provides the connection between the non-pneumatic rim and the vehicle; or, in the case of a non-pneumatic tire assembly not incorporating a wheel, a mechanical device which attaches, either integrally or separably, to the non-pneumatic tire and provides the connection between tire and the vehicle.

**Wheel-holding fixture** The fixture used to hold the wheel and tire assembly securely during testing.

## Tire Safety Information

### 3.5 TIRE SAFETY – EVERYTHING RIDES ON IT

The National Traffic Safety Administration (NHTSA) has published a brochure (DOT HS 809 361) that discusses all aspects of Tire Safety, as required by CFR 575.6. This brochure is reproduced in part below. It can be obtained and downloaded from NHTSA, free of charge, from the following web site:

[http://www.nhtsa.dot.gov/cars/rules/TireSafety/ridesonit/tires\\_index.html](http://www.nhtsa.dot.gov/cars/rules/TireSafety/ridesonit/tires_index.html)

Studies of tire safety show that maintaining proper tire pressure, observing tire and vehicle load limits (not carrying more weight in your vehicle than your tires or vehicle can safely handle), avoiding road hazards, and inspecting tires for cuts, slashes, and other irregularities are the most important things you can do to avoid tire failure, such as tread separation or blowout and flat tires. These actions, along with other care and maintenance activities, can also:

- Improve vehicle handling
- Help protect you and others from avoidable breakdowns and accidents
- Improve fuel economy
- Increase the life of your tires.

This booklet presents a comprehensive overview of tire safety, including information on the following topics:

- Basic tire maintenance
- Uniform Tire Quality Grading System
- Fundamental characteristics of tires
- Tire safety tips.

Use this information to make tire safety a regular part of your vehicle maintenance routine. Recognize that the time you spend is minimal compared with the inconvenience and safety consequences of a flat tire or other tire failure.

## Tire Safety Information

### **3.5.1 Safety First—Basic Tire Maintenance**

Properly maintained tires improve the steering, stopping, traction, and load-carrying capability of your vehicle. Underinflated tires and overloaded vehicles are a major cause of tire failure. Therefore, as mentioned above, to avoid flat tires and other types of tire failure, you should maintain proper tire pressure, observe tire and vehicle load limits, avoid road hazards, and regularly inspect your tires.

### **3.5.2 Finding Your Vehicle's Recommended Tire Pressure and Load Limits**

Tire information placards and vehicle certification labels contain information on tires and load limits. These labels indicate the vehicle manufacturer's information including:

- Recommended tire size
- Recommended tire inflation pressure
- Vehicle capacity weight (VCW—the maximum occupant and cargo weight a vehicle is designed to carry)
- Front and rear gross axle weight ratings (GAWR—the maximum weight the axle systems are designed to carry).

Both placards and certification labels are permanently attached to the trailer near the left front.

### **3.5.3 Understanding Tire Pressure and Load Limits**

Tire inflation pressure is the level of air in the tire that provides it with load-carrying capacity and affects the overall performance of the vehicle. The tire inflation pressure is a number that indicates the amount of air pressure—measured in pounds per square inch (psi)—a tire requires to be properly inflated. (You will also find this number on the vehicle information placard expressed in kilopascals (kPa), which is the metric measure used internationally.)

Manufacturers of passenger vehicles and light trucks determine this number based on the vehicle's design load limit, that is, the greatest amount of weight a vehicle can safely carry and the vehicle's tire size. The proper tire pressure for your vehicle is referred to as the "recommended

## Tire Safety Information

cold inflation pressure." (As you will read below, it is difficult to obtain the recommended tire pressure if your tires are not cold.)

Because tires are designed to be used on more than one type of vehicle, tire manufacturer's list the "maximum permissible inflation pressure" on the tire sidewall. This number is the greatest amount of air pressure that should ever be put in the tire under normal driving conditions.

### **3.5.4 Checking Tire Pressure**

It is important to check your vehicle's tire pressure at least once a month for the following reasons:

- Most tires may naturally lose air over time.
- Tires can lose air suddenly if you drive over a pothole or other object or if you strike the curb when parking.
- With radial tires, it is usually not possible to determine underinflation by visual inspection.

For convenience, purchase a tire pressure gauge to keep in your vehicle. Gauges can be purchased at tire dealerships, auto supply stores, and other retail outlets.

The recommended tire inflation pressure that vehicle manufacturers provide reflects the proper psi when a tire is cold. The term cold does not relate to the outside temperature. Rather, a cold tire is one that has not been driven on for at least three hours. When you drive, your tires get warmer, causing the air pressure within them to increase. Therefore, to get an accurate tire pressure reading, you must measure tire pressure when the tires are cold or compensate for the extra pressure in warm tires.

### **3.5.5 Steps for Maintaining Proper Tire Pressure**

- Step 1: Locate the recommended tire pressure on the vehicle's tire information placard, certification label, or in the owner's manual.
- Step 2: Record the tire pressure of all tires.
- Step 3: If the tire pressure is too high in any of the tires, slowly release air by gently pressing on the tire valve stem with the edge of your tire gauge until you get to the correct pressure.

## Tire Safety Information

- Step 4: If the tire pressure is too low, note the difference between the measured tire pressure and the correct tire pressure. These "missing" pounds of pressure are what you will need to add.
- Step 5: At a service station, add the missing pounds of air pressure to each tire that is underinflated.
- Step 6: Check all the tires to make sure they have the same air pressure (except in cases in which the front and rear tires are supposed to have different amounts of pressure).

If you have been driving your vehicle and think that a tire is underinflated, fill it to the recommended cold inflation pressure indicated on your vehicle's tire information placard or certification label. While your tire may still be slightly underinflated due to the extra pounds of pressure in the warm tire, it is safer to drive with air pressure that is slightly lower than the vehicle manufacturers recommended cold inflation pressure than to drive with a significantly underinflated tire. Since this is a temporary fix, don't forget to recheck and adjust the tire's pressure when you can obtain a cold reading.

### **3.5.6 Tire Size**

To maintain tire safety, purchase new tires that are the same size as the vehicle's original tires or another size recommended by the manufacturer. Look at the tire information placard, the owner's manual, or the sidewall of the tire you are replacing to find this information. If you have any doubt about the correct size to choose, consult with the tire dealer.

### **3.5.7 Tire Tread**

The tire tread provides the gripping action and traction that prevent your vehicle from slipping or sliding, especially when the road is wet or icy. In general, tires are not safe and should be replaced when the tread is worn down to 1/16 of an inch. Tires have built-in treadwear indicators that let you know when it is time to replace your tires. These indicators are raised sections spaced intermittently in the bottom of the tread grooves. When they appear "even" with the outside of the tread, it is time to replace your tires. Another method for checking tread depth is to place a penny in the tread with Lincoln's head upside down and facing you. If you can see the top of Lincoln's head, you are ready for new tires.

## Tire Safety Information

### **3.5.8 Tire Balance and Wheel Alignment**

To avoid vibration or shaking of the vehicle when a tire rotates, the tire must be properly balanced. This balance is achieved by positioning weights on the wheel to counterbalance heavy spots on the wheel-and-tire assembly. A wheel alignment adjusts the angles of the wheels so that they are positioned correctly relative to the vehicle's frame. This adjustment maximizes the life of your tires. These adjustments require special equipment and should be performed by a qualified technician.

### **3.5.9 Tire Repair**

The proper repair of a punctured tire requires a plug for the hole and a patch for the area inside the tire that surrounds the puncture hole. Punctures through the tread can be repaired if they are not too large, but punctures to the sidewall should not be repaired. Tires must be removed from the rim to be properly inspected before being plugged and patched.

### **3.5.10 Tire Fundamentals**

Federal law requires tire manufacturers to place standardized information on the sidewall of all tires. This information identifies and describes the fundamental characteristics of the tire and also provides a tire identification number for safety standard certification and in case of a recall.

# Tire Safety Information

## 3.5.10.1 Information on Trailer (ST) Tires

Please refer to the diagram below.

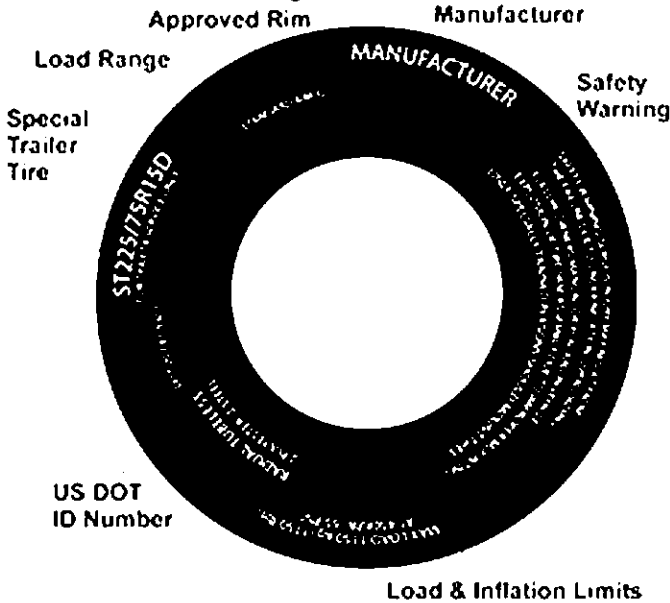

### ST

The "ST" indicates the tire is for trailer use only. "ST" tires are design for carrying heavy loads at lower speeds.

The Tire and Rim Association Standard indicates that for operation at speeds up to 65 mph, no change in maximum cold tire inflation pressure or load is required. For speeds between 66-75 mph, increase the maximum cold tire inflation pressure 10 psi.

### Next number

This three-digit number gives the width in millimeters of the tire from sidewall edge to sidewall edge. In general, the larger the number, the wider the tire.

### Next number

This two-digit number, known as the aspect ratio, gives the tire's ratio of height to width. Numbers of 70 or lower indicate a short sidewall for improved steering response and better overall handling on dry pavement.

# Tire Safety Information

## **R**

The "R" stands for radial. Radial ply construction of tires has been the industry standard for the past 20 years.

## **Next number**

This two-digit number is the wheel or rim diameter in inches. If you change your wheel size, you will have to purchase new tires to match the new wheel diameter.

## **Max. Load Dual kg (lbs) at kPa (psi) Cold**

This information indicates the maximum load and tire pressure when the tire is used as a dual, that is, when four tires are put on each rear axle (a total of six or more tires on the vehicle).

## **Max. Load Single kg (lbs) at kPa (psi) Cold**

This information indicates the maximum load and tire pressure when the tire is used as a single.

## **Load Range**

This information identifies the tire's load-carrying capabilities and its inflation limits.

## **Speed Rating**

The speed rating denotes the speed at which a tire is designed to be driven for extended periods of time. The ratings range from 99 miles per hour (mph) to 186 mph. These ratings are listed below. Note: You may not find this information on all tires because it is not required by law.

## **Maximum Load and Inflation Limits**

These numbers indicate the maximum load in kilograms (pounds) that can be carried by the tire and the greatest amount of air pressure in KPA (PSI) that should ever be put in the tire under normal driving conditions.

### **3.5.10.2 UTQGS Information**

## **Treadwear Number**

This number indicates the tire's wear rate. The higher the treadwear number is, the longer it should take for the tread to wear down. For example, a tire graded 400 should last twice as long as a tire graded 200.



# Tire Safety Information

## ST

An "ST" is an indication the tire is for trailer use only.

### **Max. Load Dual kg (lbs) at kPa (psi) Cold**

This information indicates the maximum load and tire pressure when the tire is used as a dual, that is, when four tires are put on each rear axle (a total of six or more tires on the vehicle).

### **Max. Load Single kg (lbs) at kPa (psi) Cold**

This information indicates the maximum load and tire pressure when the tire is used as a single.

### **Load Range**

This information identifies the tire's load-carrying capabilities and its inflation limits.

## **3.5.11 Tire Safety Tips**

### **Preventing Tire Damage**

- Slow down if you have to go over a pothole or other object in the road.
- Do not run over curbs or other foreign objects in the roadway, and try not to strike the curb when parking.

### **Tire Safety Checklist**

- Check tire pressure regularly (at least once a month), including the spare.
- Inspect tires for uneven wear patterns on the tread, cracks, foreign objects, or other signs of wear or trauma.
- Remove bits of glass and foreign objects wedged in the tread.
- Make sure your tire valves have valve caps.
- Check tire pressure before going on a long trip.
- Do not overload your vehicle. Check the Tire Information and Loading Placard or Owner's Manual for the maximum recommended load for the vehicle.

## 4 COUPLING TO THE TOW VEHICLE

Follow all of the safety precautions and instructions in this manual to ensure safety of persons, cargo, and satisfactory life of the trailer.

### 4.1 USE AN ADEQUATE TOW VEHICLE AND HITCH

If the vehicle or hitch is not properly selected and matched to the Gross Vehicle Weight Rating (GVWR) of your trailer, you can cause an accident that could lead to death or serious injury. If you already have a tow vehicle, know your vehicle tow rating and make certain the trailer's rated capacity is less than or equal to the tow vehicle's rated towing capacity.

Use of a hitch with a load rating less than the load rating of the trailer can result in loss of control and may lead to death or serious injury.

Use of a tow vehicle with a towing capacity less than the load rating of the trailer can result in loss of control, and may lead to death or serious injury.

Be sure your hitch and tow vehicle are rated for the Gross Vehicle Weight Rating (GVWR) of your trailer.

#### 4.1.1 Trailer Information

The "Certification / VIN Tag" location figure 4-1 and 4-2 shows the location of the Certification / Vehicle Identification Number (VIN) tag on your trailer.

## Coupling To The Tow Vehicle

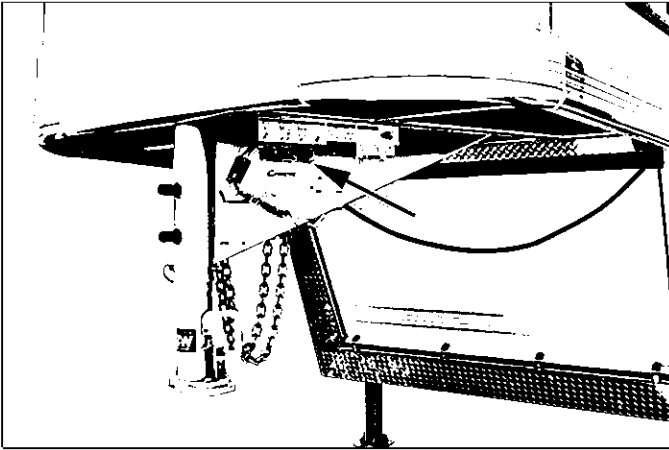

**Figure 4-1 Gooseneck Certification / VIN Tag Location**

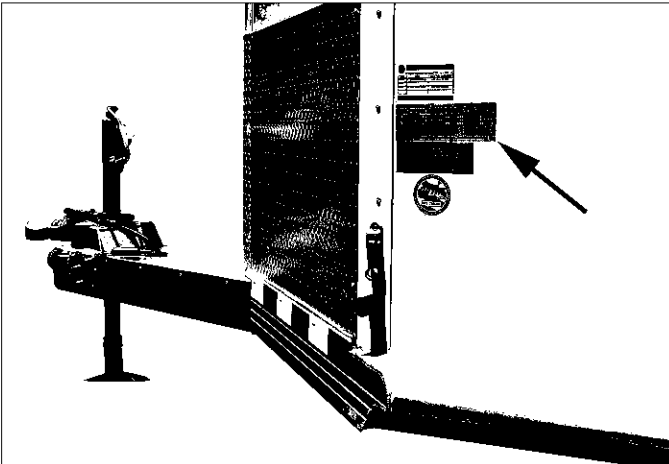

**Figure 4-2 Bumper Pull Certification / VIN Tag Location**

The trailer Certification / VIN tag contains the following critical safety information for the use of your trailer:

**MANUFACTURER:** Name of trailer manufacturer.

**DATE OF MANUFACTURE:** Month and year the trailer was manufactured.

## Coupling To The Tow Vehicle

**GVWR:** The Gross Vehicle Weight Rating is the maximum allowable gross weight of the trailer and its contents. The gross weight of the trailer includes the weight of the trailer and all of the items within it (such as cargo, water, food and other supplies). GVWR is sometimes referred to as GTW (Gross Trailer Weight), or MGTW (Maximum Gross Trailer Weight). GVWR, GTW and MGTW are all the same rating.

**GAWR:** The Gross Axle Weight Rating is the maximum gross weight that an axle can support. It is the lowest of axle, wheel, or tire rating. Sometimes the tire or wheel rating is lower than the axle manufacturer's rating, and will then determine GAWR.

The sum total of the GAWR for all trailer axles may be less than the GVWR for the trailer, because some of the trailer load is carried by the tow vehicle, rather than by the trailer axle(s). The total weight of the cargo and trailer must not exceed the GVWR, and the load on an axle must not exceed its GAWR.

**PSIC:** The “pounds per square inch-cold” is the tire pressure (Kilopascals / Pounds per Square Inch) measured when Cold.

**VIN:** The Vehicle Identification Number.

**VEHICLE TYPE:** The word Trailer followed by the model number.

**CERTIFICATION STATEMENT:** “This trailer meets all the Federal Motor Vehicle Safety Standards in effect on the date of manufacture shown above”.

### **4.1.2 Tow Vehicle**

When equipping a new vehicle or an older vehicle to tow your trailer, ask the vehicle dealer for advice on how to outfit the towing vehicle. Discuss the following information and equipment with the vehicle dealer.

#### Overall Carrying and Towing Capacity of Vehicle

Vehicle manufacturers will provide you with the maximum towing capacities of their various models, as well as the GCWR. No amount of reinforcement will give a 100 horsepower, 2,500 pound truck the towing capacity that a 300 horsepower, 5,000 pound truck has.

## Coupling To The Tow Vehicle

**Towing Hitch:** The towing hitch attached to your tow vehicle must have a capacity equal to or greater than the load rating of the trailer you intend to tow. The hitch capacity must also be matched to the tow vehicle capacity.

**Suspension System:** A tow vehicle equipped with a factory installed “Towing Package” likely comes equipped with heavy duty springs, heavy duty tires and other suspension components which are able to serve the size and weight of the trailer that the vehicle is rated to tow. However, the addition of additional equipment may further improve the tow vehicle performance. These may include adjustable air shocks, helper springs, etc.

**Brake Controller:** The brake controller is part of the tow vehicle and is essential in the operation of the electric brakes on the trailer. If your trailer has electric brakes it requires a brake controller be installed at the driver’s position. The brake controller is not the same as the safety breakaway brake system that is installed on the trailer.

**Side View Mirrors:** The size of the trailer that is being towed and your state law regulations determine the size of the mirrors. However, some states prohibit extended mirrors on a tow vehicle, except while a trailer is actually being towed. In this situation, detachable extended mirrors are necessary. Check with your dealer or the appropriate state agency for mirror requirements.

**Heavy Duty Flasher:** A Heavy Duty Flasher is an electrical component that may be required when your trailer turn signal lights are attached to the tow vehicle flasher circuit.

**Electrical Connector:** An Electrical Connector connects the light and brake systems on the trailer to the light and brake controls on the towing vehicle.

**Heavy Duty Engine Oil Cooling System:** The tow vehicle engine works harder when a trailer is being towed. Depending on the size of the trailer, you may need to install a separate engine oil cooler. Inadequate cooling may result in sudden engine failure. Ask the tow vehicle dealer if it is necessary to install a heavy duty cooling system.

**Automatic Transmission Oil Cooler:** The automatic transmission of a towing vehicle handles more power when a trailer is being towed.

## Coupling To The Tow Vehicle

Inadequate cooling will shorten transmission life, and may result in sudden transmission failure. Ask the tow vehicle dealer if it is necessary to install a separate oil cooler for the automatic transmission.

**Fire Extinguisher:** It is sensible to have a fire extinguisher in the tow vehicle.

**Emergency Flares and Emergency Triangle Reflectors:** It is wise to carry these warning devices even if you are not towing a trailer. It is particularly important to have these when towing a trailer because the hazard flashers of your towing vehicle will not operate for as long a period of time when the battery is running both the trailer lights and tow vehicle lights.

### **4.2 COUPLING AND UNCOUPLING THE TRAILER**

A secure coupling (or fastening) of the trailer to the tow vehicle is essential. A loss of coupling may result in death or serious injury. Therefore, you must understand and follow all of the instructions for coupling.

The following parts are involved in making a secure coupling between the trailer and tow vehicle:

**Coupling:** That part of the trailer connecting mechanism by which the connection is actually made to the trailer hitch. This does not include any structural member, extension of the trailer frame, or brake controller. (per SAE J684)

**Hitch:** That part of the connecting mechanism including the ball support platform and ball and those components that extend and are attached to the towing vehicle, including bumpers intended to serve as hitches. (per SAE J684)

**Safety chains:** Chains are permanently attached to the trailer such that if the coupler connection comes loose, the safety chains or cables can keep the trailer attached to the tow vehicle. With properly rigged safety chains or cables, it is possible to keep the tongue of the trailer from digging into the road pavement, even if the coupler-to-hitch connection comes apart.

## Coupling To The Tow Vehicle

**Trailer lighting (and braking) connector:** A device that connects electrical power from the tow vehicle to the trailer. Electricity is used to turn on brake lights, running lights, and turn signals as required. In addition, if your trailer has a separate braking system, the electrical connector will also supply power to the trailer brakes from the tow vehicle.

**Breakaway switch:** If the trailer becomes de-coupled from the towing vehicle, the breakaway switch lanyard, attached independently to the tow vehicle, will pull a pin in the emergency electrical breakaway switch on the trailer.

The breakaway switch is activated by a separate battery supply in the trailer such as to energize the trailer brakes independently of the towing vehicle. It is important to check the state of charge of the emergency breakaway battery before each trip. Simply pull the pin out of the switch by hand and then try to pull the trailer.

If you feel a significant drag force the brakes are activated. Be sure to re-insert the pin in the breakaway switch. Also be sure to allow enough slack in the breakaway brake lanyard such that the switch will only activate (pin pulls out) if the coupler connection comes loose.

**Jack:** A device on the trailer that is used to raise and lower the trailer tongue. The jack is sometimes called the “landing gear.”

## Coupling To The Tow Vehicle

### WARNING

An improperly coupled trailer can result in death or serious injury.

Do not move the trailer until:

- The coupler is secured and locked to hitch;
- The safety chains are secured to the tow vehicle; and
- The trailer jack(s) are fully retracted.

Do not tow the trailer on the road until:

- Tires and wheels are checked;
- The trailer brakes are checked;
- The breakaway switch is connected to the tow vehicle;
- The load is secured to the trailer; and
- The trailer lights are connected and checked.

## COUPLER DESIGNS

Trailers are produced with one of three coupler devices. One of the sections below will pertain to your trailer.

- Bumper pull (Ball Hitch) Coupler
- Gooseneck Hitch Coupler

If the coupler on your trailer does not resemble one of the couplers shown in the figures, see the separate coupler instructions. If you do not have separate coupler instructions, call Cimarron Trailers, Inc. at 405-222-4800 for a free copy.

## Coupling To The Tow Vehicle

### 4.2.1 Trailer with Ball Hitch Coupler

A ball hitch coupler connects to a ball that is located on or under the rear bumper of tow vehicle. The trailer jack or landing gear will raise and lower the trailer coupler. See figure 4-3.

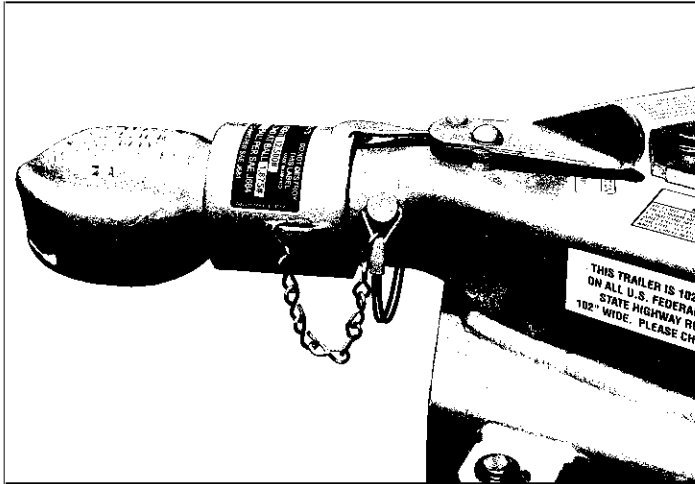

**Figure 4-3 Trailer With Ball Hitch Coupler**

Be sure the Ball Hitch coupler is suitable for the size and weight of the trailer. The load rating of the coupler and the necessary ball size are listed on the trailer tongue. You must provide a hitch and ball for your tow vehicle, where the load rating of the hitch and ball is equal to or greater than that of your trailer. Also, the ball size must be the same as the coupler size. If the hitch ball is too small, too large, is underrated, is loose or is worn, the trailer can come loose from the tow vehicle, and may cause death or serious injury.

**THE TOW VEHICLE, HITCH AND BALL MUST HAVE A RATED TOWING CAPACITY EQUAL TO OR GREATER THAN THE TRAILER Gross Vehicle Weight Rating (GVWR).**

**IT IS ESSENTIAL THAT THE HITCH BALL BE OF THE SAME SIZE AS THE COUPLER. (Cimarron's standard ball size is 2 5/16" for bumper pull models.)**

## Coupling To The Tow Vehicle

The ball size and load rating (capacity) are marked on the ball; hitch capacity is marked on the hitch.

### 4.2.1.1 Before coupling the trailer to the tow vehicle

- Be sure the size and rating of hitch ball match the size and rating of the coupler. Hitch balls and couplers are marked with their size and rating.

### **WARNING**

Coupler-to-hitch mismatch can result in uncoupling, leading to death or serious injury.

Be sure the **LOAD RATING** of the hitch ball is equal or greater than the load rating of the coupler.

Be sure the **SIZE** of the hitch ball matches the size of the coupler.

- Wipe the hitch ball clean and inspect it visually and by feel for flat spots, cracks and pits.

### **WARNING**

A worn, cracked or corroded hitch ball can fail while towing, and may result in death or serious injury.

Before coupling trailer, inspect the hitch ball for wear, corrosion and cracks.

Replace worn or damaged hitch ball.

- Rock the ball to make sure it is tight to the hitch, and visually check that the hitch ball nut is solid against the lock washer and hitch frame.
- Wipe the inside and outside of the coupler clean and inspect it visually for cracks and deformations; feel the inside of the coupler for worn spots and pits.
- Be sure the coupler is tight to the tongue of the trailer. All coupler fasteners must be visibly solid against the trailer frame.

## Coupling To The Tow Vehicle

### WARNING

A loose hitch ball nut can result in uncoupling, leading to death or serious injury.

Be sure the hitch ball is tight to the hitch before coupling the trailer.

- Using the jack, raise the bottom surface of the coupler to be above the top of the hitch ball.

#### 4.2.1.2 Prepare the coupler and hitch

- Lubricate the hitch ball and the inside of the coupler with a thin layer of automotive bearing grease.
- Remove latch safety pin and open the coupler locking mechanism. In the open position, the coupler is able to drop fully onto the hitch ball. See the coupler instructions for details of placing the coupler in the “open” position.
- Slowly back up the tow vehicle so that the hitch ball is near or aligned under the coupler.

#### 4.2.1.3 Couple the trailer to the tow vehicle

- Using the jack, lower the trailer tongue until the coupler fully engages the hitch ball. If the coupler does not line up with the hitch ball, adjust the position of the tow vehicle.
- Close the coupler and engage the coupler locking mechanism (A). See figure 4-4. In the engaged position, the locking mechanism securely holds the coupler to the hitch ball. Be sure the coupler is all the way on the hitch ball and the locking mechanism is engaged.
- Insert the lock pin (B) through the hole to lock the coupler and engage the safety retainer. See figure 4-4.

## Coupling To The Tow Vehicle

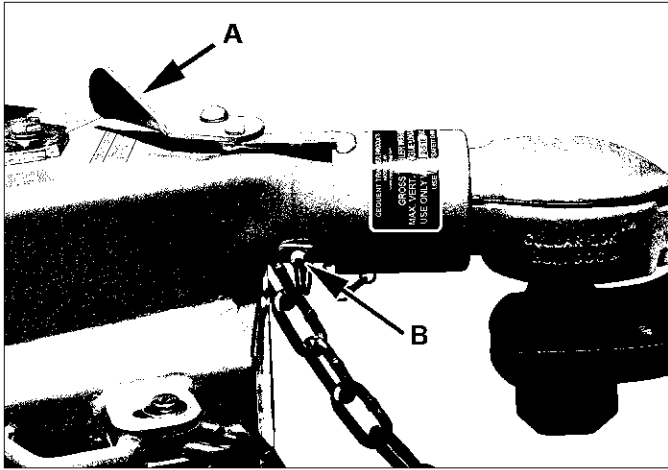

**Figure 4-4 Locked Ball Hitch Coupler**

- A properly engaged locking mechanism will allow the coupler to raise the rear of the tow vehicle. Using the trailer jack, test to see that you can raise the rear of the tow vehicle by 1 inch, after the coupler is locked to the hitch.

### **NOTICE**

**Overloading can damage the tongue jack. Do not use the tongue jack to raise the tow vehicle more than 1 inch.**

**If the coupler cannot be secured to the hitch ball, do not tow the trailer.** Call Cimarron Trailers, Inc. at 405-222-4800 or your dealer for assistance.

- Lower the trailer so that its entire tongue weight is held by the hitch, and continue retracting the jack to its fully retracted position.
- It is recommended to remove the caster wheel from the bottom of the parking jack for additional ground clearance while in transit. To remove the caster wheel, retract the jack until the wheel clears the ground. Then remove the bail pin attaching the wheel to the jack. Store wheel & bail pin in secure location while in transit. Continue retracting jack to its fully retracted position.

## Coupling To The Tow Vehicle

### 4.2.1.4 Rig the safety chains

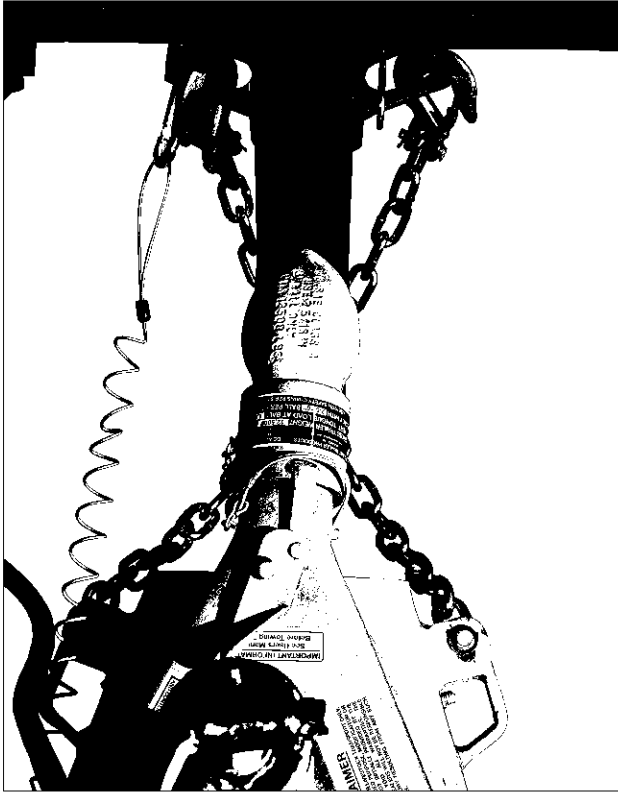

**Figure 4-5 Proper Safety Chain Arrangement**

- Visually inspect the safety chains and hooks for wear or damage. Replace worn or damaged safety chains and hooks before towing.
- Rig the safety chains so that they:  
Cris-cross underneath the coupler so if the trailer uncouples, the safety chains can hold the tongue up above the road. See figure 4-5.  
Loop around a frame member of the tow vehicle or to holes provided in the hitch system (but, do **not** attach them to an interchangeable part of the hitch assembly)  
Attach safety hooks up from underneath the hole (do not just drop into hole); and  
Provide enough slack to permit tight turns, but not be close to the road surface to drag.

## Coupling To The Tow Vehicle

### WARNING

Improper rigging of the safety chains can result in loss of control of the trailer and tow vehicle, leading to death or serious injury, if the trailer uncouples from the tow vehicle.

- Fasten chains to frame of tow vehicle. Do not fasten chains to any part of the hitch unless the hitch has holes or loops specifically for that purpose.
- Cross chains underneath hitch and coupler with enough slack to permit turning and to hold tongue up, if the trailer comes loose.

#### 4.2.1.5 Attach and test electric breakaway brake system

If the coupler or hitch fails, a properly connected and working breakaway brake system will apply the brakes on the trailer. The safety chains will keep the tow vehicle attached and as the trailer brakes are applied, the trailer/tow vehicle combination will come to a controlled stop.

The breakaway brake system includes a brake controller, battery and a switch with a pullpin, and lanyard. Read and follow the instructions here as well as the instructions that have been prepared by the breakaway brake manufacturer. If you do not have these instructions, call Cimarron Trailers, Inc. at 405-222-4800 for a free copy.

The breakaway brake system is fitted with a “charging” capability that draws power from the tow vehicle. If the electrical system on your tow vehicle does not provide power to the breakaway brake battery, you must periodically charge the battery to keep the breakaway brake system in working order.

## Coupling To The Tow Vehicle

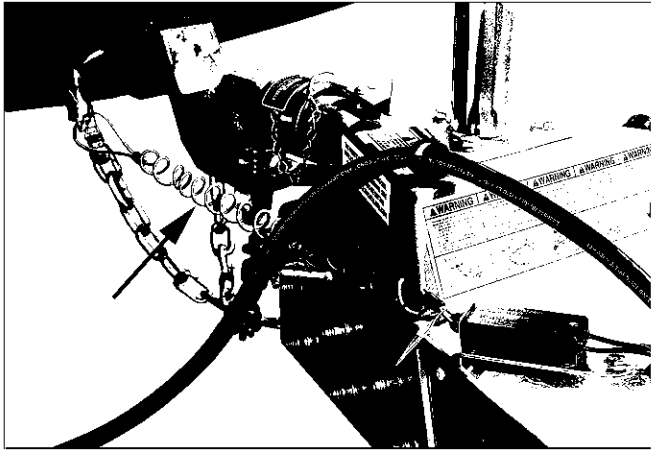

*Figure 4-6 Breakaway Brake Lanyard*

- Connect the pullpin lanyard to the tow vehicle so that the pullpin will be pulled out before all of the slack in the safety chains is taken up. See figure 4-6. Do **not** connect the pullpin lanyard to a safety chain, hitch ball or hitch ball assembly. This would keep the breakaway brake system from operating when it is needed.
- To test the breakaway brake battery, remove the pullpin from the switch and attempt to pull the trailer forward. You should feel the trailer resisting being towed, but the wheels will not necessarily be locked. If the brakes do not function, do not tow the trailer until brakes, or battery are repaired.
- Immediately replace the pullpin. The breakaway brake system battery discharges rapidly when the pullpin is removed.

## Coupling To The Tow Vehicle

### WARNING

An ineffective or inoperative breakaway brake system can result in a runaway trailer, leading to death or serious injury if the coupler or hitch fails.

The breakaway lanyard must be connected to the tow vehicle, and NOT to any part of the hitch.

Before towing the trailer, test the function of the breakaway brake system. If the breakaway brake system is not working, do not tow the trailer. Have it serviced or repaired.

Do **not** tow the trailer with the breakaway brake system ON because the brakes will overheat which can result in permanent brake failure.

### WARNING

Failure to replace the pullpin will prevent brakes from working, leading to loss of control, serious injury or death.

If you do not use your trailer for three or more months, or during winter months:

- Store the battery indoors; and
- Charge the battery every three months.

Replace the breakaway brake battery according to the intervals specified by the brake manufacturer.

## Coupling To The Tow Vehicle

### 4.2.1.6 Connect the electrical connector

Connect the trailer electrical connector (A) to the tow vehicle's electrical system using the 7-pin electrical connector. See figure 4-7.

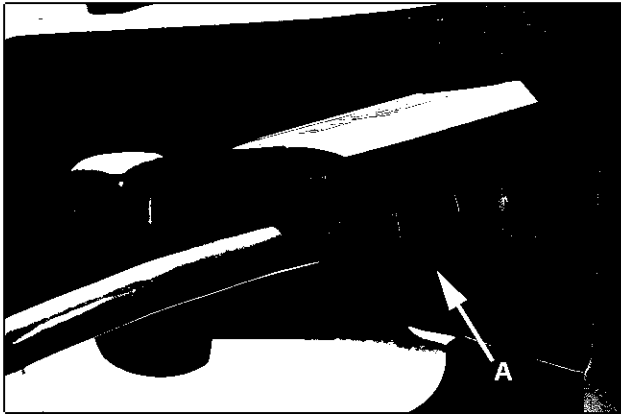

**Figure 4-7, 7-Pin Electrical Connector**

- Check all lights for proper operation.  
Clearance and Running Lights (Turn on tow vehicle headlights).  
Brake Lights (Step on tow vehicle brake pedal).  
Turn Signals (Operate tow vehicle directional signal lever).
- Check brakes for proper operation using brake controller mounted in the cab.

If your trailer has brakes, your tow vehicle will have a brake controller that applies the trailer brakes. Before towing the trailer on the road, you must operate the brake controller while trying to pull the trailer in order to confirm that the brakes operate. While towing the trailer at less than 5 m.p.h., manually operate the brake controller in the tow vehicle cab. You should feel the operation of the trailer brakes.

## Coupling To The Tow Vehicle

### WARNING

Improper electrical connection between the tow vehicle and the trailer will result in inoperable lights and electric brakes, and can lead to collision.

Before each tow:

- Check that the taillights, brake lights and turn signals work.
- Check that the electric brakes work by operating the brake controller inside the tow vehicle.

#### 4.2.1.7 Uncoupling the ball hitch trailer

Follow these steps to uncouple your ball hitch trailer from the tow vehicle:

- Unload the trailer.
- Block trailer tires to prevent the trailer from rolling.
- Disconnect the electrical connector.
- Disconnect the breakaway brake switch lanyard.
- Disconnect the safety chains from the tow vehicle.
- Unlock the coupler and open it.
- Before extending jack, make certain the ground surface below the jack pad will support the tongue load.
- Extend the jack part way, replace the caster wheel & bail pin.
- Extend the jack to transfer the weight of the trailer tongue to the jack. Raise the trailer tongue until the coupler is above the hitch ball.

#### 4.2.2 Trailer with Gooseneck Coupler

A gooseneck coupler on the trailer connects to a gooseneck ball that you must have installed in the bed of the tow vehicle. See figure 4-8.

## Coupling To The Tow Vehicle

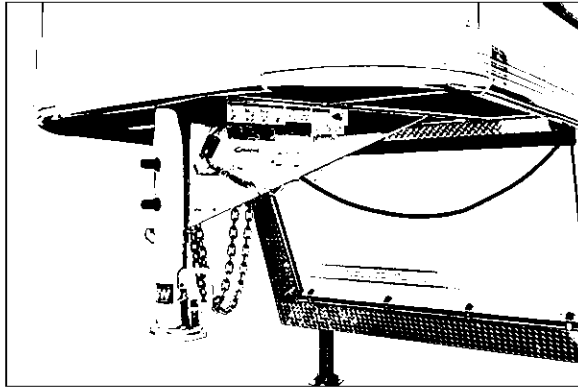

*Figure 4-8 Trailer With Gooseneck Coupler*

The Gooseneck ball receiver is suited for the size and weight of the trailer. The load rating of the coupler and the necessary ball size are listed on the gooseneck.

You must provide a gooseneck ball and support structure that is marked with a rating that meets or exceeds the GVW Rating of your trailer **and** matches the size of the gooseneck ball receiver. If the gooseneck ball is too small, is underrated, is loose or is worn, the trailer can come loose from the tow vehicle, and may lead to death or serious injury.

**THE TOW VEHICLE, SUPPORT STRUCTURE AND GOOSENECK BALL MUST HAVE A RATED TOWING CAPACITY EQUAL TO OR GREATER THAN THE TRAILER Gross Vehicle Weight Rating (GVWR).**

**IT IS ESSENTIAL THAT THE GOOSENECK BALL BE OF THE SAME SIZE AS THE GOOSENECK BALL RECEIVER. (Cimarron's standard ball size is 2 5/16" for gooseneck models.)**

The ball size and load rating (capacity) are marked on the ball; hitch capacity is marked on the hitch.

## Coupling To The Tow Vehicle

### WARNING

Coupler-to-hitch mismatch can result in uncoupling, leading to death or serious injury.

Be sure the **LOAD RATING** of the hitch ball is equal or greater than the load rating of the coupler.

Be sure the **SIZE** of the hitch ball matches the size of the coupler.

#### 4.2.2.1 Before coupling the trailer to the tow vehicle

- Be sure the size and rating of the gooseneck ball match the size and rating of the receiver. Gooseneck balls and receivers are marked with their size and ratings.
- Wipe the gooseneck ball clean and inspect it visually and by feel for flat spots, cracks and pits.

### WARNING

A worn, cracked or corroded gooseneck ball can fail while towing, and may result in death or serious injury.

Before coupling the trailer, inspect the gooseneck ball for wear, corrosion and cracks; and replace worn or damaged gooseneck ball.

- Rock the ball to make sure it is tight to the ball support, and visually check that the gooseneck ball nut is solid against the lock washer and ball support frame.

### WARNING

A loose gooseneck ball can result in uncoupling, leading to death or serious injury.

Be sure the gooseneck ball nut is tight before coupling the trailer.

- Wipe the inside and outside of the receiver clean and inspect it visually for cracks; and feel the inside of the receiver for worn spots and pits. If any of these conditions exist, have the receiver replaced before coupling the trailer.

## Coupling To The Tow Vehicle

- Lubricate the inside of the gooseneck ball receiver with automotive bearing grease.
- Be sure the receiver is tight to the trailer. All receiver fasteners must be visibly solid against the trailer frame.
- If the tow vehicle has a tailgate, lower it.
- Remove the jack crank handle from its holder and place on the end of the shaft. See figure 4-9.

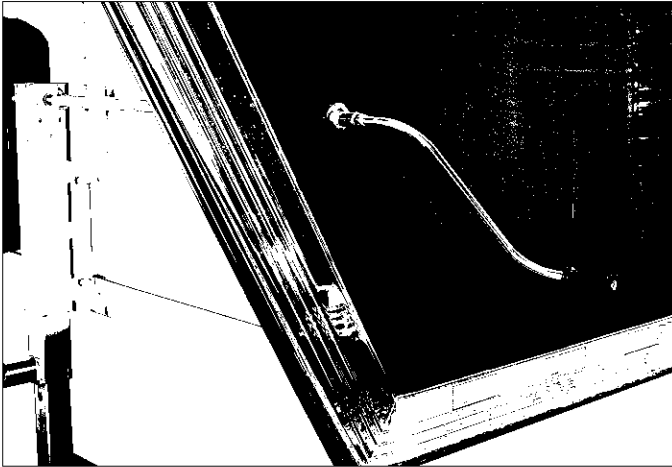

**Figure 4-9 Jack Crank Handle Installed**

- Rotate the handle/crank clockwise to raise the bottom surface of the gooseneck to be above the top of the gooseneck ball.
- Replace removable handle in holder.

### 4.2.2.2 Prepare the ball receiver and gooseneck ball

- Block trailer wheels.
- Set coupler into the open position by lifting up on the handle and slide the locking plate into detent.
- If the tow vehicle is equipped with a tailgate, lower it.
- Slowly back up the tow vehicle so that the gooseneck ball is aligned under the gooseneck ball receiver.

## Coupling To The Tow Vehicle

### **⚠ WARNING**

If the trailer drops during coupling, death or serious injury may result.

There must be no one under the trailer or coupler before or during the coupling operation.

#### 4.2.2.3 Couple the trailer to the tow vehicle

- Retract the jack causing the gooseneck ball receiver to lower so it can fully engage the gooseneck ball and transfer the weight of the trailer tongue to the towing vehicle hitch. Visually check that the hitch ball is fully seated in the coupler. If the receiver does not line up with the ball, raise the receiver again and adjust the position of the tow vehicle. Then lower the receiver over the ball.
- Slide the locking plate back towards trailer. Slide locking handle/pin (A) down into the hole in locking plate. When using a recessed ball, check to make sure handle and locking plates are clear of any interference with safety chains and D-rings.
- For more information refer to “B&W 25k Gooseneck Coupler” instructions in your trailer packet. If you do not have these instructions, call Cimarron Trailers, Inc. at 405-222-4800 for a free copy.

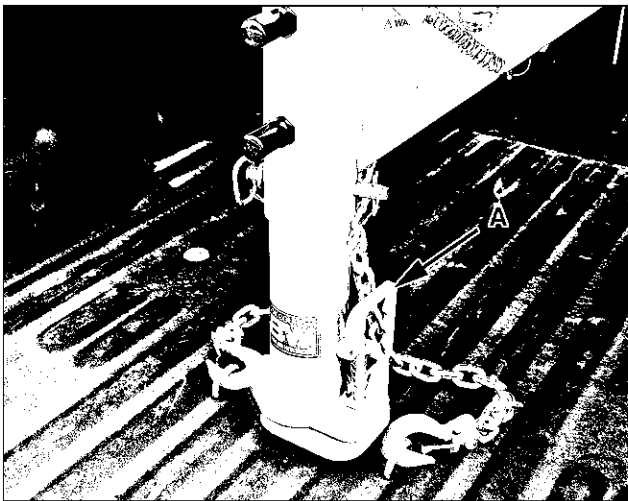

**Figure 4-10 Gooseneck Coupler Locked**

## Coupling To The Tow Vehicle

- A properly engaged locking mechanism will allow the coupler to raise the rear of the tow vehicle. Using the trailer jack, test to see that you can raise the rear of the tow vehicle by 1 inch.

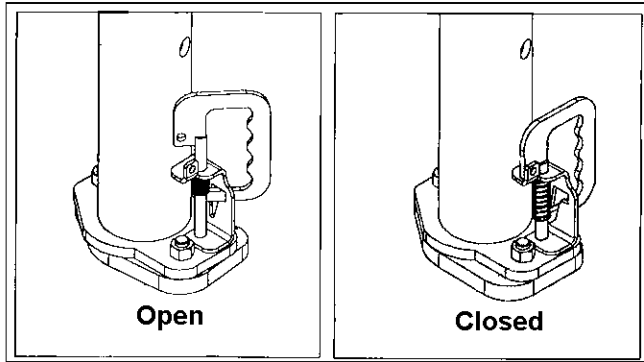

*Figure 4-11 Handle in Open and Closed Position*

### **WARNING**

Coupler must be FULLY seated onto the ball and CLOSED securely before towing. Use 2 5/16" ball ONLY. Failure to do so may result in serious injury or death.

#### To Couple:

1. Block trailer wheels.
2. Align hitch ball beneath coupler.
3. Set the coupler into the open position by lifting up on the handle and sliding the locking plate away from the trailer.
4. Lower the trailer onto the hitch ball.
5. Visually check that the hitch ball is fully seated in the coupler.
6. Slide the locking plate back towards trailer. Slide locking handle/pin down into the hole of the locking plate. When using a recessed ball, check to make sure handle and locking plate are clear of any interference with safety chains and D-rings.
7. Insert (optional) theft deterrent lock through hole in fixed plate.

#### To Uncouple:

1. Block trailer wheels.

## Coupling To The Tow Vehicle

2. Remove lock (if equipped) and set the handle into the open position.
3. Slide the locking plate into the open position and raise the trailer from the hitch ball.

### *NOTICE*

**Overloading can damage the drop leg jack. Do not use the drop leg jack to raise the tow vehicle more than 1 inch.**

**If the gooseneck ball cannot be secured to the receiver, do not tow the trailer.** Call Cimarron Trailers, Inc. at 405-222-4800 or your dealer for assistance.

- After testing to see that the receiver is properly secured and locked to the ball, retract the jack to its fully retracted position, remove and stow the crank handle.
- Return the drop leg to the upper position. The drop leg is held in the lowered position with a plunger pin. Rotating the plunger pin while pulling it outward will cause it to come out of engagement with the drop leg and the leg will rapidly rise. See figure 4-11.
- Raise the tow vehicle tailgate.

## Coupling To The Tow Vehicle

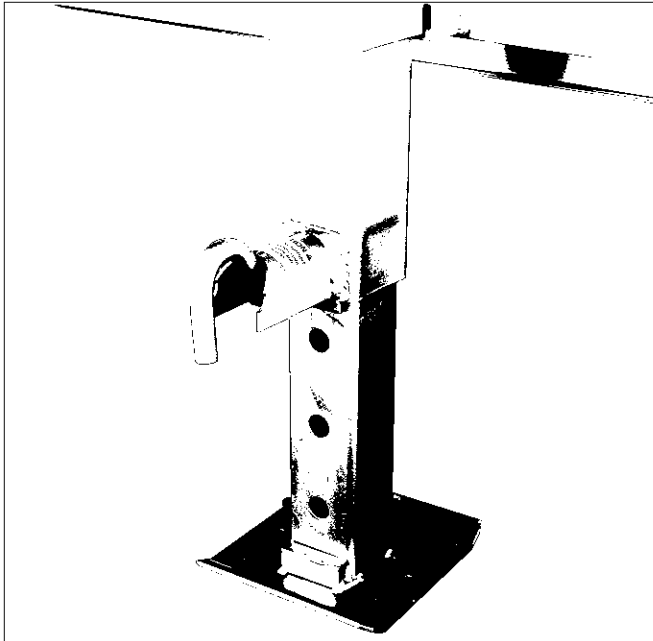

*Figure 4-12 Spring Loaded Drop Leg Jack*

### CAUTION

The drop legs are heavily spring loaded in the lowered position. They will rapidly return to the upper position when released and can inflict serious bruises, scrapes or pinching.

Keep your feet, shins and hands well clear of the drop legs and drop leg bases when releasing the drop legs.

Always wear shoes or boots while performing this operation

#### 4.2.2.4 Rig the safety chains

Visually inspect the safety chains and hooks for wear or damage. Replace worn or damaged safety chains and hooks before towing.

- Rig the safety chains so that they attach to the “safety chain receivers” on the tow vehicle. See figure 4-13. If you are not certain of the hitch provisions for receiving safety chains, contact the hitch manufacturer

## Coupling To The Tow Vehicle

or installer. Do NOT attach the safety chains to the gooseneck ball or its support; and

- Rig the safety chains so they have sufficient slack to permit turning, but not too much slack – the safety chains must keep the gooseneck on the tow vehicle bed if the trailer uncouples.

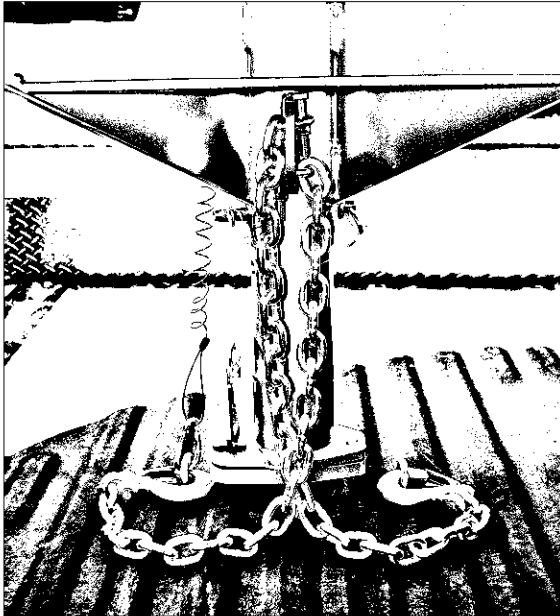

*Figure 4-13 Proper Safety Chain Arrangement*

### **⚠** WARNING

Improper rigging of the safety chains can result in loss of control of the trailer and tow vehicle, leading to death or serious injury, if the trailer uncouples from the tow vehicle.

- Fasten chains to safety chain receivers on the hitch, not to ball.
- Have sufficient slack to permit turning and to keep gooseneck on bed of tow vehicle, if the trailer comes loose.

#### 4.2.2.5 Attach and test the breakaway brake system

If the coupler or hitch fails, a properly connected and working breakaway brake system will apply electric brakes on the trailer. The safety chains

## Coupling To The Tow Vehicle

will keep the tow vehicle attached and as the brakes are applied at the trailer's axles, the trailer/tow vehicle combination will come to a controlled stop.

The breakaway brake system includes a brake controller, battery and a switch with a pullpin and lanyard. Read and follow the instructions here as well as the instructions that have been prepared by the breakaway brake controller manufacturer. If you do not have these instructions, call Cimarron Trailers, Inc. at 405-222-4800 for a free copy.



**Figure 4-14 Breakaway Brake Lanyard**

## Coupling To The Tow Vehicle

The breakaway brake system may be fitted with a charging facility that draws power from the tow vehicle. If the electrical system on your tow vehicle does not provide power to the breakaway brake battery you must periodically charge the battery on the trailer to keep the breakaway brake system in working order.

- Visually inspect the breakaway brake system for broken parts.
- Connect the pullpin lanyard (B) to the tow vehicle so that the pullpin will be pulled out before all of the slack in the safety chains is taken up. See figure 4-14. Do **not** connect the pullpin lanyard to a safety chain, safety chain receiver or to the gooseneck ball or its support. This would keep the breakaway brake system from operating when it is needed. Contact the hitch manufacturer or installer if you are not certain of the hitch provisions for breakaway brake connection
- To test the breakaway brake battery, remove the pullpin from the switch and attempt to pull the trailer forward. You should feel the trailer resisting being towed, but the wheels will not necessarily lock up.
- Immediately replace the pullpin. The breakaway brake system battery discharges rapidly when the pullpin is removed.

### WARNING

An ineffective or inoperative breakaway brake system can result in a runaway trailer leading to death or serious injury if the coupler or hitch fails.

Connect the breakaway cable to the tow vehicle; and **NOT** to the safety chain, safety chain receiver, gooseneck ball or gooseneck ball support.

Test the function of the breakaway brake system before towing the trailer. Do not tow the trailer if the breakaway brake system is not working. Have it serviced or repaired.

Do **not** tow the trailer with the breakaway brake system ON because the brakes will overheat which can result in permanent brake failure.

## Coupling To The Tow Vehicle

### **⚠ WARNING**

Failure to replace the pullpin will prevent brakes from working, leading to loss of control, serious injury or death.

If you do not use your trailer for three or more months, or during winter months:

- Store the battery indoors; and
- Charge the battery every three months.

Replace the breakaway brake battery according to the intervals specified by brake manufacturer.

#### 4.2.2.6 Connect the electrical connector

Connect the trailer electrical connector (A) to the tow vehicle's electrical system using the 7-pin electrical connector. See figure 4-15.



**Figure 4-15, 7-Pin Electrical Connector**

Check all lights for proper operation:

- Clearance and Running Lights (Turn on tow vehicle headlights).
- Brake Lights (Step on tow vehicle brake pedal).
- Turn Signals (Operate tow vehicle directional signal lever).
- Check brakes for proper operation.

## Coupling To The Tow Vehicle

If your trailer has brakes, your tow vehicle will have a brake controller that applies the trailer brakes. Before towing the trailer on the road, you must operate the brake controller while trying to pull the trailer in order to confirm that the brakes operate. While towing the trailer at less than 5 m.p.h., manually operate the brake controller in the tow vehicle cab. You should feel the operation of the trailer brakes.

### WARNING

Improper electrical connection between the tow vehicle and the trailer will result in inoperable lights and electric brakes, and can lead to collision.

Before each tow:

- Check that the taillights, brake lights and turn signals work.
- Check that the electric brakes work by operating the brake controller inside the tow vehicle.

#### 4.2.2.7 Uncoupling the gooseneck trailer

Follow these steps to uncouple your gooseneck hitch trailer from the tow vehicle:

- Unload the trailer.
- Block trailer tires to prevent the trailer from rolling.
- Disconnect the electrical connector.
- Disconnect the breakaway brake switch lanyard.
- Disconnect the safety chains from the tow vehicle.
- Raise handle and rotate locking plate forward into OPEN position.
- Rotate the lock plate to a position that permits the gooseneck ball to exit the receiver.
- Before releasing drop leg jack, make certain ground surface below jack base will support the trailer tongue load.
- Rotate the drop leg plunger pin handle so that the plunger pin is released from the drop leg.
- Push down on the drop leg base with your foot to place a drop leg to the desired lowered position.
- Rotate the plunger pin handle so that the plunger pin is attempting to engage the drop leg.

## Coupling To The Tow Vehicle

- Slowly raise your foot, permitting the drop leg to raise. The plunger pin will engage a hole in the drop leg.

### CAUTION

The drop legs are heavily spring loaded in the lowered position. They will rapidly return to the upper position when released and can inflict serious bruises, scrapes or pinching.

Keep your feet, shins and hands well clear of the drop legs and drop leg bases when releasing the drop legs.

Always wear shoes or boots while performing this operation

- Be sure the plunger pin is fully engaged. Push it in by hand if necessary. The bent part of the plunger pin handle must be touching the plunger pin housing.
- If your trailer has two drop leg jacks, lower them both to the same level, following the above instructions.

### NOTICE

**If the drop legs are not set at the same level, one of the drop leg jacks can be overloaded and can be damaged.**

- Remove the jack crank handle from its holder and place on the end of the shaft.
- On two speed jacks, move the handle in or out to engage high gear.
- Rotate the crank handle clockwise to slowly extend the jack and transfer the weight of the trailer tongue to the jack.
- When the drop leg base contacts the ground, shift the gearbox into low gear.

### NOTICE

**Do not use high speed to lift the trailer, the drop leg jack mechanism can be damaged.**

**High speed is used only to rapidly move the drop leg base into contact with the ground.**

## Coupling To The Tow Vehicle

- Continue to extend the jack, making sure that the ground is providing stable and level support for the trailer.
- Lower the tow vehicle tailgate
- After the jack is extended and the gooseneck ball receiver is well clear of the gooseneck ball, to permit driving the tow vehicle away, remove and stow the crank handle.
- Slowly drive the tow vehicle away from the trailer.
- Raise the tow vehicle tailgate.

### **4.2.3 Adjust Gooseneck Hitch Height**

The height of the ball receiver on the trailer must be adjusted so that the trailer, when loaded to rated capacity, is level while connected to the tow vehicle. There must also be adequate clearance between the bottom of the trailer and the sides of the tow vehicle bed. A level trailer allows equal weight distribution on the axles.

Connect trailer to tow vehicle (see Coupling To The Tow Vehicle) and load the trailer to rated capacity (see Loading The Trailer).

Park the tow vehicle and trailer on a firm level surface.

Stand away from the trailer and visually verify if the trailer is level front-to-rear. If the front of the trailer is higher than the rear, the hitch must be retracted. If the front of the trailer is lower than the rear, the hitch must be extended.

Unload and uncouple trailer from tow vehicle (See Unloading The Trailer and Uncoupling The Trailer).

### **WARNING**

Improper gooseneck height adjustment can result in overloaded tires, blowout and loss of control, leading to death or serious injury.

Adjust the gooseneck receiver so that the loaded trailer is level.

## Coupling To The Tow Vehicle

Loosen jam nuts and set bolts (A). Remove retaining pin (B) then use CAUTION removing load bearing pin (C) being careful not to drop the inner tube coupler assembly (D) causing injury. There are four (4) height adjustment holes for the load bearing pin allowing for a total of 16" of height adjustment. Do NOT exceed 16" maximum extension from the fully retracted position. Locate the proper hole location and replace the load bearing pin. The load bearing pin must be fully inserted through both the inner and outer tubes and the retaining pin installed in order for the coupler to support its rated load. Tighten the set bolts and jam nuts to minimize movement and vibration in the coupler during towing. Set bolts and jam nuts **MUST BE TIGHTENED TO A MINIMUM OF 125 lb/ft OF TORQUE**. See figure 4-16.

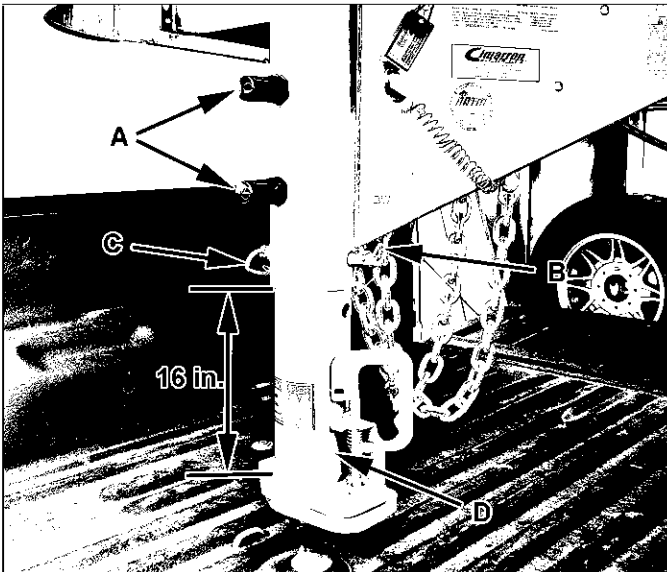

**Figure 4-16 Maximum Gooseneck Adjustment**

## 5 LOADING THE TRAILER

Improper trailer loading causes many accidents and deaths. To safely load a trailer, you must consider:

- Overall load weight;
- Load weight distribution;
- Proper tongue weight; and
- Securing the load properly.

To determine that you have loaded the trailer within its rating, you must consider the *distribution* of weight, as well as the total weight of the trailer and its contents. The trailer axles carry most of the total weight of the trailer and its contents (Gross Vehicle Weight, or “GVW”). The remainder of the total weight is carried by the tow vehicle hitch. It is essential for safe towing that the trailer tongue and tow vehicle hitch carry the proper amount of the loaded trailer weight, otherwise the trailer can develop an undesirable sway at towing speeds, or the rear of the towing vehicle can be overloaded. Read the “Tongue Weight” information that follows.

The load distribution must be such that no component part of the trailer is loaded beyond its rating. This means that you must consider the rating of the tires, wheels and axles. For tandem and triple axle trailers, you must make sure that the front-to-rear load distribution does not result in overloading any axle.

Towing stability also depends on keeping the center of gravity as low as possible. Load heavy items on the floor and over the axles. When loading additional items, be sure to maintain even side-to-side weight distribution and proper tongue weight. The total weight of the trailer and its contents must never exceed the total weight rating of the trailer (Gross Vehicle Weight Rating, or “GVWR”).

## Loading The Trailer

### **WARNING**

An overloaded trailer can result in loss of control of the trailer, leading to death or serious injury.

Do not exceed the trailer Gross Vehicle Weight Rating (GVWR) or an axle Gross Axle Weight Rating (GAWR).

Do not load a trailer so that the weight on any tire exceeds its rating.

### Tongue Weight

It is critical to have a portion of the trailer load carried by the tow vehicle. That is, the trailer tongue must exert a downward force on the hitch. This is necessary for two reasons. First, the proper amount of tongue weight is necessary for the tow vehicle to be able to maintain control of the tow vehicle/trailer system. If, for example, the tongue exerts an upward pull on the hitch, instead of pushing down on it (because the trailer is overloaded behind its axles), the rear wheel of the tow vehicle can lose traction or grip and cause loss of control. Also, even if there is some, but not enough weight on the tongue, the trailer can become unstable at high speeds. Remember, the faster you go, the more likely the trailer is to sway.

If, on the other hand, there is too much tongue weight, the tow vehicle is prone to jack-knife. Furthermore, the front wheels of the tow vehicle can be too lightly loaded and cause loss of steering control and traction, if the front wheels are driving.

In addition to tow vehicle control, tongue weight is necessary to insure that the trailer axles do not exceed their Gross Axle Weight Rating (GAWR).

In the following table, the second column shows the **RULE OF THUMB** percentage of total weight of the trailer plus its cargo (Gross Trailer Weight, or "GTW") that should appear on the tongue of the trailer. For example, a trailer with a gooseneck hitch, with a loaded weight of 12,000 pounds, should have 20-30% of 12,000 pounds (2400-3600 lbs.) on the gooseneck. After loading, be sure to check that none of the axles are overloaded.

**NOTE:** Due to custom manufacturing requirements and changes, the above rule of thumb may vary greatly on highly customized models. Check

## Loading The Trailer

with Cimarron Trailers at 405/222-4800 for tongue weights on specific trailers.

### Tongue Weight as a Percentage of Loaded Trailer Weight

Type of Hitch	Percentage
Ball Hitch (or Bumper Hitch)	10-20%
Gooseneck Hitch	20-30%

### WARNING

Improper tongue weight (load distribution) can result in loss of control of the trailer, leading to death or serious injury.

Make certain that tongue weight is within the allowable range.

Be sure to:

- Distribute the load front-to-rear to provide proper tongue weight (see chart);
- Distribute the load evenly, right and left, to avoid tire overload; and
- Keep the center of gravity low.

## 5.1 CHECKING TONGUE WEIGHT

To check the tongue weight, the tow vehicle and trailer must be on level ground, as they will be when the trailer is being towed.

For lighter trailers the recommended method of checking tongue weight is to use an accessory called a “tongue weight scale.” If a tongue weight scale is not available from your dealer, call Cimarron Trailers, Inc. at 405-222-4800 for assistance.

For most trailers, it is easier to go to a truck stop where there is a “certified” scale. Pull the trailer onto the scale and decouple it from the tow vehicle, leaving just the trailer on the scale. Get a “ticket”, which lists the total trailer weight. Re-connect the trailer to your tow vehicle and the drive the tow vehicle wheels off the scale, just leaving the trailer axles on

## Loading The Trailer

the scale. Get a second “ticket”, which lists the trailer’s axle weight. Simply subtract the axle weight from the total weight to determine the hitch weight. While you are at the scale, to weigh the entire combination vehicle. This result should be less than the Gross Combined Weight Rating (GCWR) for your towing vehicle. Some scales allow you to get individual axle weights also. If this is possible, get the tow vehicles front and rear axle weights to make sure they are in the same proportion as the tow vehicle alone, and that the rear axle is not overloaded.

### 5.2 SECURING THE CARGO

Since the trailer “ride” can be bumpy and rough, you must secure your cargo so that it does not shift while the trailer is being towed.

#### **WARNING**

Shifting cargo can result in loss of control of the trailer, and can lead to death or serious injury.

Tie down all loads with proper sized fasteners, ropes, straps, etc.

### 5.3 LOADING HORSES (HORSE TRAILER)

Couple the trailer to the tow vehicle before loading. This is essential for the bumper pull trailer because the tongue of a bumper pull trailer can rise during loading, before the cargo is properly distributed.

The cargo-carrying portion of a horse trailer is designed only for carrying horses. Do not transport people, livestock, containers of hazardous substances, or containers of flammable substances.

#### **WARNING**

Do not transport people inside the trailer, even if it has living quarters. The transport of people puts their lives at risk and may be illegal.

## Loading The Trailer

### WARNING

Do not carry "loose" livestock in your horse trailer. They can cause the trailer to become unstable and can result in loss of control.

You must use a trailer designed to carry "loose" livestock.

### WARNING

Do not transport flammable, explosive, poisonous or other dangerous materials in your trailer.

Exceptions:

- Fuel in the tanks of vehicles that are being towed.
- Fuel stored in proper containers used in trailer living quarters for cooking.
- Fuel stored in the tank of an on-board generator.

Before loading a horse in your trailer, inspect the interior of the trailer. The interior of the trailer must be smooth, and have no protruding objects. There should be no loose objects that could move about and startle or injure the horse. Check the walls, floor, dividers, etc., for loose and broken parts, welds, hinges, etc.

### **5.3.1 Preparing the Horse Trailer for Loading**

Open windows and vents to provide ventilation. Consider the weather and transport conditions (i.e. on warm sunny days, maximum ventilation is required). Do not carry a horse without providing ventilation, even in coldest weather. Ventilation is critical for the well being of your horses. Know your horses and adjust ventilation for your horses' comfort. Be sure window latches are in a flush position, so they do not present a protrusion that can injure your horse.

Tighten any loose or protruding screws in the walls.

Remove or secure loose objects, (i.e. butt bars, saddles, tack and equipment) so that items will not move during towing.

Inspect for cracks at the welds on the divider hinges, and the welds on the tie rings. If you are able to open any cracks in or near these welds by lifting the dividers or by twisting the tie rings, have the weld repaired before loading your horses.

## Loading The Trailer

### CAUTION

The trailer interior may contain hazards to a horse that can result in its serious injury or death.

Before loading a horse, inspect the trailer interior and adjust or repair all loose and protruding features such as handles, loose or broken parts of the trailer, etc.

Before towing trailer:

- Lock all stall dividers.
- Be sure all saddles, tack and equipment, as well as horse(s), are prevented from being thrown about.

### WARNING

Improper weld repair will lead to early failure of the trailer structure and can cause serious injury or death.

Do not repair cracked or broken welds unless you have the skills and equipment to make a proper repair. Have the welds repaired by your dealer.

### **5.3.2 Loading the Horse Trailer**

The trailering of horses introduces many variables that are not present in the trailering of non-living cargo. Horses are prone to take flight when they feel threatened or pain. In the confines of a trailer, the flight response can cause serious injury or death to a human handler. Even experienced and docile horses can be frightened.

Horses must be slowly acclimated to trailering. Be sure the horse's first trips are short trips, so you can gauge its reaction. Some will take to the experience easily, but others will strongly protest. You must act according to your horse's demeanor.

## Loading The Trailer

### WARNING

When a horse is frightened, it is capable of inflicting serious injury or death to a human handler.

Know your horse's temperament before attempting to trailer it.

Handling a horse that is not trailer-acclimated may result in injury or death, or damage to your trailer.

Do not haul an unbroken horse in this trailer.

Horses must have a halter.

1. If the trailer has living quarters, close and lock the door between the living quarters and the horse area.
2. If your trailer is fitted with swinging loading doors, open them fully and fasten them against the trailer using the door holdbacks.
3. If the trailer is fitted with a drop ramp, carefully lower it to the ground.
4. Open all stall dividers to their OPEN (against the wall) position.
5. Some trailers have a removable rear door center post and a fold away rear tack room wall (see Accessories Section 8). Removing the door post and moving the tack room wall creates a larger opening at the rear of the trailer to assist the loading. After loading, return the wall and door post to their normal positions for travel.
6. Lead the horse into the trailer by a halter or lead rope. If the horse shows any signs of distress, stop loading, and calm the horse.

### WARNING

Improper weight distribution of the horses in the trailer will result in an unstable trailer.

Always load the first horse into the forward-most stall.

7. Tie the horse to the trailer interior by fastening the quick connect or tying the lead rope to the tie ring, or other facility provided on the trailer wall for attachment of the lead rope. A rule of thumb is to leave about 18 inches of free rope between the attachment point on the trailer and the horse. The layout of the horse trailer has been designed to safely contain your horse. The trailer is equipped with stall dividers and tie rings to secure the horse, and has a rubber floor mat to keep

## Loading The Trailer

shoed horses from slipping on the metal underfloor. Restraining a horse without using a combination of a tie-strap and stall divider may result in serious injury or death to the horse.

### CAUTION

Failure to secure a horse using a tie strap may result in its serious injury or death.

8. Close and latch the stall divider.
9. If additional horses are to be loaded, repeat steps 6-8 for each horse – lead the horse, secure the horse, close and lock latch the stall divider.
10. After the last horse has been loaded, close any unused dividers.
11. Double check that each horse is tied to the trailer and each stall divider is LATCHED in the CLOSED position.
12. If your trailer is fitted with a butt bar or butt strap to keep the horse away from the door, hook and lock the butt bar in place.
13. Release the door holdbacks and swing the hinged doors to a closed position and raise the drop ramp if equipped.
14. Secure the trailer door/ramp so that the door/ramp cannot open while the trailer is being towed.
15. If your trailer is fitted with feed doors, close and secure them.

### WARNING

If the door opens, your cargo may be ejected onto the road, resulting in death or serious injury to other drivers.

Always secure the door/ramp latch after closing.

16. Check the horses after 5 to 10 miles or 10 minutes of towing, and then at least once per hour thereafter. Open a feed door or other access and look for signs of stress, cuts, or injury. On long trips it is recommended that horses be removed from the trailer every 6-10 hours for exercise, food and watering.

## Loading The Trailer

### WARNING

Horses may kick when back door/ramp is opened.  
Stay clear when opening back door.

#### **5.4 LOADING LIVESTOCK (LIVESTOCK TRAILER)**

Couple the trailer to the tow vehicle before loading. This is essential for the bumper pull trailer because the tongue of a bumper pull trailer can rise during loading, before the cargo is properly distributed.

The cargo-carrying portion of a livestock trailer is for carrying livestock (other than horses) only. The livestock trailer does not have the equipment required for the safe transport of horses, e.g. stall dividers, tie rings and a rubber floor mat. Do not transport people, containers of hazardous substances, or containers of flammable substances.

### WARNING

Do not transport people inside the trailer, even if it has living quarters. The transport of people puts their lives at risk and may be illegal.

### WARNING

Do not transport flammable, explosive, poisonous or other dangerous materials in your trailer.

Exceptions:

- Fuel in the tanks of vehicles that are being towed.
- Fuel stored in proper containers used in trailer living quarters for cooking.
- Fuel stored in the tank of an on-board generator.

## Loading The Trailer

### CAUTION

Hauling a horse in a livestock trailer may result in its serious injury or death.

Do not carry a horse in a livestock trailer. Use a trailer designed to carry horses.

#### **5.4.1 Preparing the Livestock Trailer for Loading**

Before loading livestock in your livestock trailer, inspect the interior of the trailer. The interior of the trailer must be smooth, and have no protruding objects, such as bolts, broken parts of trailer interior, etc. A protruding object can injure your livestock.

1. Tighten any loose or protruding bolts in the walls.
2. Remove or secure loose objects, so no items will move during towing.

### CAUTION

The interior space of a trailer may contain hazards that result in serious injury or death to trailered livestock.

Inspect the interior of the trailer before loading livestock.

- Adjust or repair all loose and protruding features.
- All cargo and equipment, besides the livestock, must be prevented from being thrown about before towing trailer.

#### **5.4.2 Loading the Livestock Trailer**

The trailering of livestock introduces many variables that are not present in the trailering of non-living cargo. Livestock may resist being loaded into a trailer.

## Loading The Trailer

### WARNING

Large animals are capable of inflicting serious injury or death to a human handler.

Know your animals' temperament before attempting to trailer them.

1. Position the trailer as needed to load the livestock.
2. If the trailer is fitted with a drop ramp, carefully lower it to the ground.
3. Open and secure the loading door.
4. Open and secure the interior gates as necessary.
5. Load the livestock into the trailer.
6. Gate the livestock tightly to keep them from moving or falling during transportation.
7. Close the loading doors and raise the drop ramp if equipped.
8. Secure the trailer door/ramp so that the catch and door cannot open while the trailer is being towed.

### WARNING

If the door opens, your cargo may be ejected onto the road, resulting in death or serious injury to other drivers.

Always secure the door/ramp latch after closing.

## 5.5 LOADING CARGO (CARGO TRAILERS)

Couple the trailer to the tow vehicle before loading. The tongue of a bumper pull trailer can rise during loading, before the cargo is properly distributed. To measure the tongue weight, you will have to uncouple the trailer after it is loaded.

Do not transport people, containers of hazardous substances, cans or containers of flammable substances. However, fuel in the tank of an off-road vehicle, or a car or motorcycle, etc., may be carried inside of your cargo trailer.

## Loading The Trailer

### WARNING

Do not transport people inside the trailer, even if it has living quarters. The transport of people puts their lives at risk and may be illegal.

### WARNING

Do not transport flammable, explosive, poisonous or other dangerous materials in your trailer.

Exceptions:

- Fuel in the tanks of vehicles that are being towed.
- Fuel stored in proper containers used in trailer living quarters for cooking.
- Fuel stored in the tank of an on-board generator.

### **5.5.1 Preparing the Cargo Trailer for Loading**

1. Before loading cargo into your trailer, inspect the interior of the trailer.
2. Enclosed trailers may be fitted with “D”-ring hold-downs, and/or a track system that can be used to secure the cargo. Inspect the “D”-rings and track system for looseness or signs of bending before loading the cargo onto the trailer.

### WARNING

Damaged or loose “D”-rings can break, allowing cargo to become loose inside the trailer. Loose cargo can shift the center of gravity, and result in loss of control of the trailer.

Inspect “D”-rings, and test them for looseness before loading cargo.

Do not use a damaged or loose “D”-ring to secure cargo.

### **5.5.2 Loading the Enclosed Trailer**

Enclosed trailers may be fitted with a drop ramp door. The weight of the drop ramp door is partially held by a spring and cable counterbalance

## Loading The Trailer

assembly. If this assembly is out of adjustment or worn out, it will not provide the expected assistance for slow and careful lowering and raising of ramp.

### WARNING

A spring and cable counterbalance can inflict serious injury if it breaks, or if incorrectly adjusted.

Inspect the cable and cable ends each time the door is operated.

Do not attempt to service the counterbalance. Take the trailer to your dealer for service.

1. Carefully lower the drop ramp to the ground.
2. Load the cargo up the drop ramp and into the trailer, with approximately 60% of the cargo in the front half of the trailer. If the trailer has living quarters, the cargo area of your trailer may have ventilation openings near the floor. Do not block these ventilation openings. These openings are provided to exhaust potentially deadly fumes.

### WARNING

Accumulation of hazardous fumes can cause death or serious injury.

Do not block access to ventilation ports.

3. Secure the cargo to the trailer using appropriate straps, chains and tensioning devices.
4. Close the drop ramp door and secure the trailer door catch so that the catch and door cannot open while the trailer is being towed.

### WARNING

If the door opens, your cargo may be ejected onto the road, resulting in death or serious injury to other drivers.

Always secure the door latch after closing.

# 6 CHECKING THE TRAILER BEFORE AND DURING EACH TOW

## 6.1 PRE-TOW CHECKLIST

Before towing, double-check all of these items:

- Tires, wheels and lug nuts (see the “Major Hazards” section starting on page 6 of this manual)
- Tire Pressure. Inflate tires on trailer and tow vehicle to the pressure stated on the Certification / VIN label.
- Coupler secured and locked (see the “Coupling to the Tow Vehicle” chapter starting at Page 43 of this manual).
- Safety chains properly rigged to tow vehicle, not to hitch or ball (see the “Coupling to the Tow Vehicle” chapter starting at Page 43 of this manual)
- Test Tail, Stop, and Turn Lights
- Test trailer brakes.
- Safety breakaway switch lanyard fastened to tow vehicle, not to safety chains (see the “Coupling to the Tow Vehicle” chapter starting at Page 44 of this manual).
- Cargo properly loaded, balanced and secured.
- Tongue weight and weight distribution set-up.
- Doors and gates latched and secured
- Fire extinguisher
- Flares and reflectors

## 6.2 MAKE REGULAR STOPS

After each 50 miles, or one hour of towing, stop and check the following items:

- Coupler secured
- Safety chains are fastened and not dragging
- Cargo secured
- Cargo door latched and secured.

## 7 BREAKING-IN A NEW TRAILER

### 7.1 RETIGHTEN LUG NUTS AT FIRST 10, 25 & 50 MILES

Wheel lugs can shift and settle quickly after being first assembled, and must be checked after the **first** 10, 25 and 50 miles of driving. Failure to perform this check may result in a wheel coming loose from the trailer, causing a crash leading to death or serious injury. Refer to Section 9.2.12 for the proper lug nut tightening sequence and torque value.

#### WARNING

Lug nuts are prone to loosen after initial installation, which can lead to death or serious injury.

Check lug nuts for tightness on a new trailer or when wheel(s) have been remounted after the first 10, 25 and 50 miles of driving.

### 7.2 ADJUST BRAKE SHOES AT FIRST 200 MILES

Brake shoes and drums experience a rapid initial wear. The brakes must be adjusted after the first 200 miles of use, and each 3,000 miles thereafter. Some axles are fitted with a mechanism that will automatically adjust the brake shoes when the trailer is “hard stopped” from a rearward direction. Read your axle and brake manual to see if your brakes adjust automatically. All 3500 - 7000 lb. axles use Dexter® "NEV-R-ADJUST" self adjusting brakes as standard equipment. If you do not have the axle and brake manual, call Cimarron Trailers, Inc. at 405-222-4800 for a free copy.

A hard stop is used to:

Confirm that the brakes work;

Confirm that the trailer brakes are properly synchronized with the tow vehicle brakes using the brake controller in the tow vehicle;

## Breaking-In A New Trailer

Adjust the brake shoes as necessary.

For surge or hydraulic brakes, check the Master cylinder reservoir for fluid.

If your trailer is not fitted with automatically adjusting brakes, the brakes will need to be manually adjusted. See Section 9.2.4.2, “Manually adjusting brake shoes,” for instructions.

### **7.3 SYNCHRONIZING THE BRAKE SYSTEMS**

Trailer brakes are designed to work in synchronization with the brakes on the tow vehicle. When the tow vehicle and trailer braking systems are synchronized, both braking systems contribute to slowing, and the tongue of the trailer will neither dive nor rise sharply.

#### **WARNING**

If trailer and tow vehicle brakes do not work properly together, death or serious injury can occur.

Road test the brakes in a safe area at no more than 30 m.p.h. before each tow

To insure safe brake performance and synchronization, read and follow the axle/brake and the brake controller manufacturer's instructions. If you do not have these instructions, call Cimarron Trailers, Inc. at 405-222-4800 for a free copy.

## 8 ACCESSORIES

This chapter provides some basic information for the safe operation of several accessories. For many accessories, such as generators and air conditioners, the manufacturer of the accessory has provided instructions. You must read and follow these instructions before using the accessory. If you are uncertain whether you have all of the instructions, call Cimarron Trailers, Inc. at 405-222-4800 before operating the accessory. The following accessories are described in this section:

- Remove Center Post
- Small Animal Gates
- Traveling Center Gate
- Hydraulic Landing Gear
- Air Ride Suspension
- Windows
- Drop Down Feed Doors
- Dividers
- Doors, Gates and Ramps
- Paddle Latch & Striker Plate
- Bar Lock Latch & Cargo Vise Catch
- Front Walk-In Tack Room
- Rear Tack Compartment
- Adjustable Saddle Racks
- Drop Ramp Door
- Slideout

Some accessories introduce the risk of fire and carbon monoxide poisoning. Make sure you have a fire extinguisher charged and ready. Check the fire extinguisher at least once a month. If the fire extinguisher is discharged even partially, it must be recharged. Follow the fire extinguisher manufacturer's instructions for recharging the extinguisher after use.

## Accessories

### 8.1 ELECTRIC/HYDRAULIC LANDING GEAR

The landing gear on your trailer may be powered with an electric motor that runs a hydraulic pump. The landing gear is operated up or down using controls located near the landing gear. See figures 8-1 and 8-2.

If the motor does not operate, such as when the battery is fully discharged, the landing gear can be operated manually by operating the pump located on the landing gear. Refer to the instructions provided by the landing gear manufacturer that were included with your trailer.

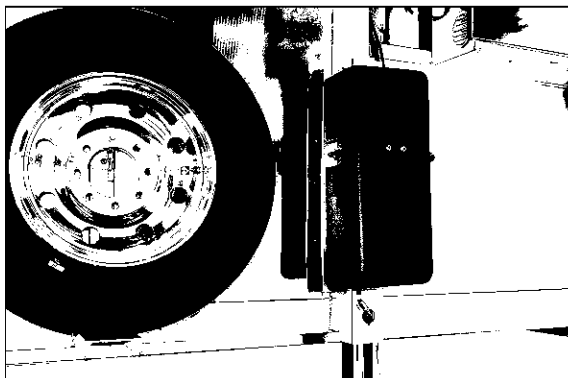

*Figure 8-1 Electric/Hydraulic Landing Gear*

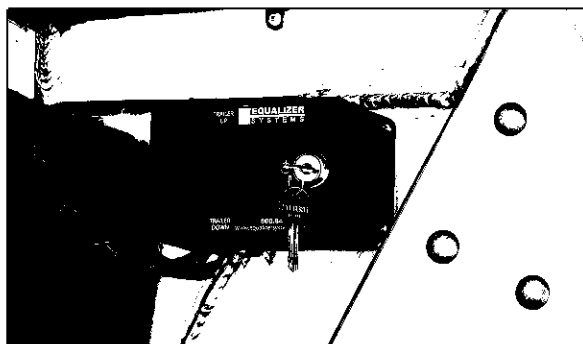

*Figure 8-2 Electric/Hydraulic Landing Gear Control*

### 8.2 AIR RIDE SUSPENSION

Your trailer may be equipped with air ride suspension. The compressed air for the suspension can come from the tow vehicle or a compressor

## Accessories

mounted to the trailer. Refer to the suspension manufacturer's information for operating instructions.

### 8.3 WINDOWS

When operating sliding window, activate the pressure release in the center of the window and slide the moveable section to the opposite side. To close the window, reverse the above procedure, keeping hands and fingers clear.

One or more windows installed in the living quarters area are egress style windows that can be opened and used as an exit in an emergency. To open, pull out on the red latches (A) and push out on the bottom of the window. See figure 8-3.

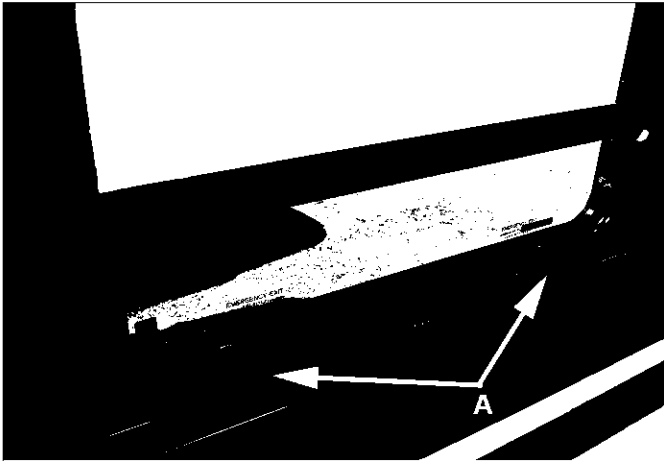

*Figure 8-3 Egress Window Latches*

### 8.4 RECESSED PADDLE LATCHES & STRIKER PLATE

Recessed paddle latches & striker plates are used on; drop down feed doors, manger doors, access doors, front tack room doors, etc. Open the latch by lifting out on the recessed paddle and pull the door toward you. See figure 8-4.

## Accessories

To close the door place your hand on the door next to the latch and firmly push the door closed. The door will latch with a clicking sound. See figure 8-5.

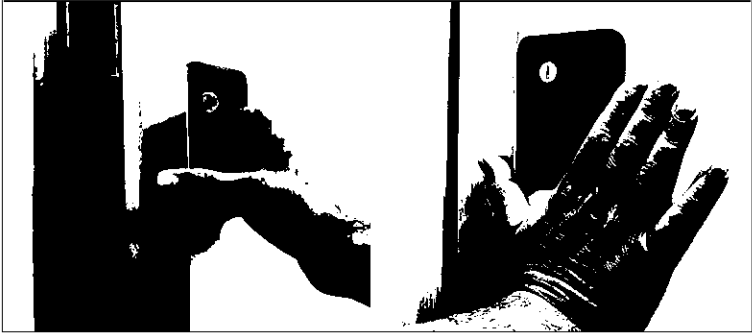

**Figure 8-4 Open Paddle Latch**   **Figure 8-5 Close Paddle Latch**

Check to make sure the door has latched by inspecting the play in the latch paddle. This can be done by gently feeling how much movement is remaining in the paddle after it has latched. A properly latched paddle will have no more movement than (about one sixteenth of an inch) what is felt when the paddle latch is in a neutral position, such as when the door is in an open position. Any excess movement means the spring loaded catch bolt is not fully engaged in the striker plate, and the door should be re-shut and or adjusted until proper latching is achieved.

**PADDLE LOCKS** - After latching paddle latch, it is recommended to lock all doors when in transit for safety and security reasons. This can be done by inserting your key into the tumbler on the paddle handle, and turn the tumbler clockwise one quarter turn until it stops, then remove key, to unlock reverse procedure. See figures 8-6 and 8-7.

Note: The lock on the paddle only locks the paddle handle itself to prevent entrance from the outside. It does not lock the spring loaded catch bolt, which actually holds the door closed. This latch will have a smooth interior plate, without a release handle. All paddle latch locks will be keyed the same throughout each trailer.

## Accessories



**Figure 8-6**  
**Paddle Lock Tumbler**

**Figure 8-7**  
**Paddle Smooth Interior Plate**

**DEAD BOLT LOCKS** - Recessed paddle latches used in front tack rooms and mid tack rooms have an additional lock made into the housing of the latch. This is a dead bolt lock that has its own mechanically operated catch bolt. This latch will have an interior release handle and a dead bolt engagement knob. Dead bolt locks offer increased security while inside and with the dead bolt locked from the outside the door cannot open. Dead bolt locks are keyed separately from paddle latches for personal security reasons. See figures 8-8 and 8-9.

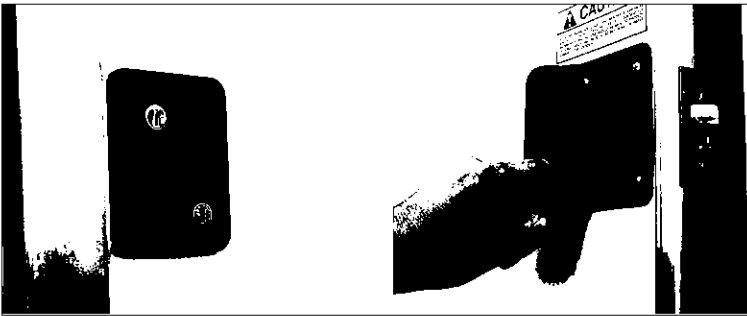

**Figure 8-8**  
**Exterior Dead Bolt Lock**

**Figure 8-9**  
**Interior Dead Bolt Handle & Knob**

**STRIKER PLATES** - Both, paddle locks and dead bolts locks, latch into the striker plate on the door-jamb. Striker plate adjustment determines the amount of tension on the paddle latch. Striker plates may need to be adjusted over time to keep doors latching properly. To adjust, loosen the two screws holding the plate, move the plate inward or outward and retighten the screws. Moving the plate inward will tighten the door seal

## Accessories

and make the latch firmer to operate. Moving the plate outward will loosen the door seal and make the latch softer to operate. See figure 8-10.

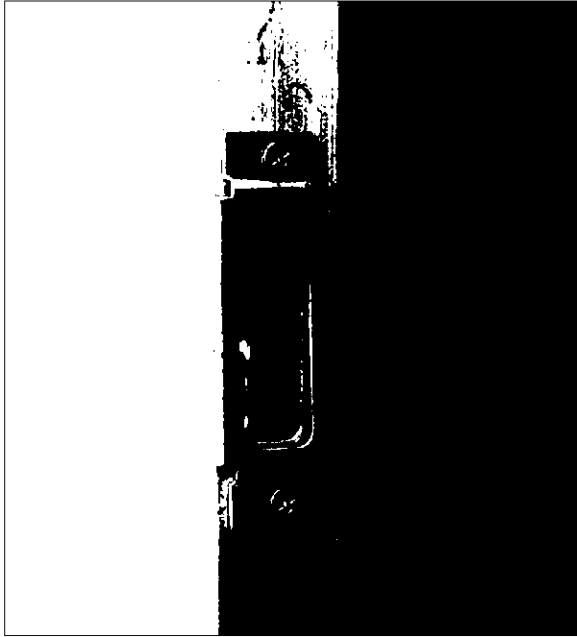
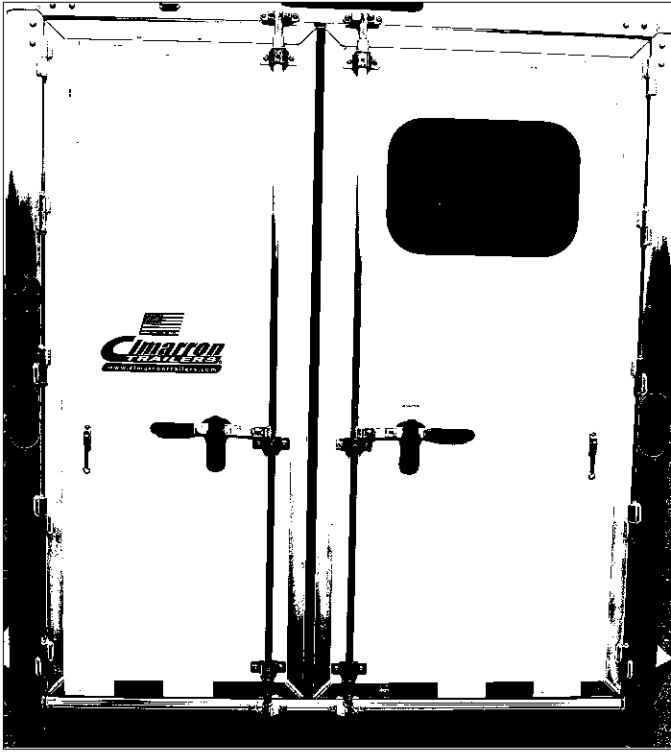

*Figure 8-10 Adjustable Striker Plate*

### **8.5 BAR LOCK LATCH & CARGO VISE CATCH**

Bar lock latches are commonly used in a vertical position on rear stall doors, full height side stall doors and in a horizontal position on some ramp doors. Bar lock latches consist of a 1" pipe extending the height of a door, held in place by top, center, and bottom rod guides, lug forks on each end of pipe latch into keepers mounted onto the door jamb. The complete assembly is controlled by a center mounted pivoting handle that latches into a cargo vise catch. See figure 8-11.

## Accessories



**Figure 8-11 Typical Bar Lock Latch & Cargo Vise Catch**

To open the bar lock latch, release the handle from the cargo vise by tipping the center catch bar away from the handle, then raise the handle up and free from the cargo vise catch. Once the handle clears the vise catch pull the handle out from the door rotating the pipe and in turn rotating the lug clear from the keepers. See figure 8-12, 8-13 and 8-14. Because a bar lock latch spans the full height of the door and ties the top and bottom of the door opening together, it is the strongest most secure type of door latch available for stall doors. To close the bar latch reverse the above procedure, being sure that both the top and bottom lug and keepers are fully engaged.

## Accessories

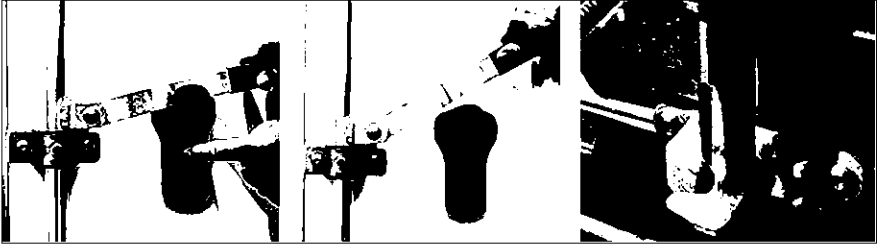

**Figure 8-12**  
*Trip Center Catch*

**Figure 8-13**  
*Raise, Clear & Rotate Handle*

**Figure 8-14**  
*Clear Lug & Keeper*

When replacing the handle into the cargo vise catch, be sure the handle fully engages with the vise catch center bar until it snaps closed. See figure 8-15 and 8-16. After latching cargo vise catch, it is recommended to lock it when in transit, for safety and security reasons. This can be done by inserting your key into the tumbler on the cargo vise catch, and turn the tumbler clockwise one quarter turn until it stops, then remove key, to unlock reverse procedure. Always check the bar lock handle is properly locked into the cargo vise catch, before towing.



**Figure 8-15**  
*Lug & Keeper Fully Engaged*

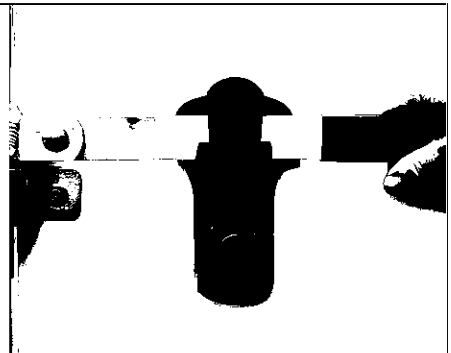

**Figure 8-16**  
*Handle Fully Engaged In Vise Catch*

### **8.6 DROP-DOWN FEED DOORS**

All factory installed drop-down feed doors on Cimarron trailers are made in house of structural grade aluminum, with a sliding radius corner window and a drop-down aluminum safety bar grill. These doors are

## Accessories

designed to provide the utmost safety for your animals. The drop-down aluminum safety bar grill makes traveling in high temperatures more moderate, allowing ample air flow through the trailer. Do not attach or tie animals, feed equipment or tack directly to the head grill.

Open the drop-down feed door by lifting out on the recessed paddle latch located at the front center of the door. Pull door down exposing the aluminum safety bar grill. See figure 8-17. The safety bar grill can also be dropped down to allow feeding or total head exposure while parked. Raise the feed door slightly until the safety bar grill tab (A) is aligned with the opening in the guide and then pull safety bar grill outward. See figure 8-18. Never leave the safety bar grill down or open during transit. Return the safety bar grill back to closed position by inserting the grill tab (A) back into the opening in the guide. Close the drop-down feed door by swinging the door back up into the opening. Check the paddle latch in the drop-down feed door to be sure it is fully latched and engaged.



**Figure 8-17 Drop Down Feed Door**

## Accessories

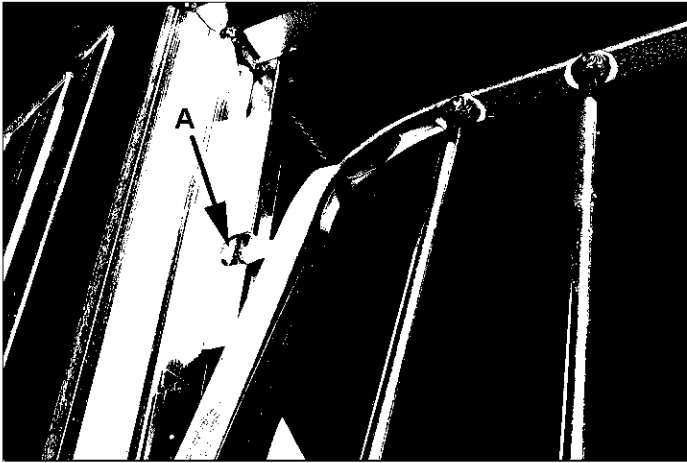

**Figure 8-18 Open Safety Bar Grill**

### **⚠ WARNING**

Do not leave the safety bar grill open while in transit.  
Death or serious injury to the horse may result.

## **8.7 STALL DIVIDERS**

### **⚠ WARNING**

Do not attempt to release or open a stall divider with an animal's weight applying pressure on the divider.

Serious injury may result from the divider swinging open with force.

Before unlatching a stall divider:

- Be certain the animal is not applying pressure on the divider;
- Stand in a safe position, while maintaining control of divider when unlatching;
- Keep hands and fingers clear of pinch points during opening and closing.

To open divider, (with no animal pressure on divider) place one hand on the divider, take the free hand and pull outward on the latch (A), releasing the latch and freeing the spring loaded divider to swing open. For divider

## Accessories

latching or closing, simply push the divider closed, the latch will engage when fully closed. See figure 8-19.

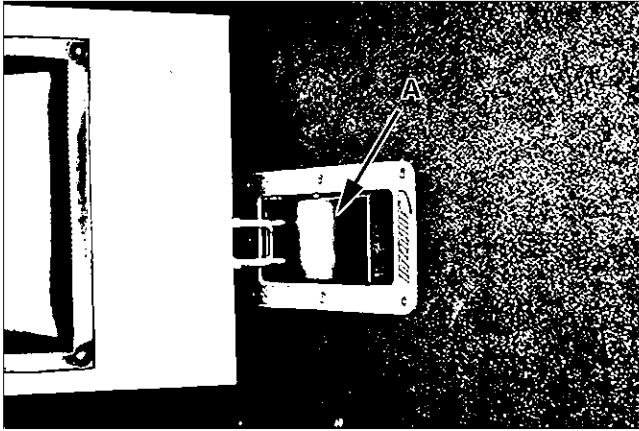

**Figure 8-19 Stall Divider Latch**

The latch striker bolt is adjustable to compensate for wear. Loosen nuts (B) and adjust striker bolt in or out as necessary to keep divider securely closed. Tighten nuts (B). See figure 8-20.

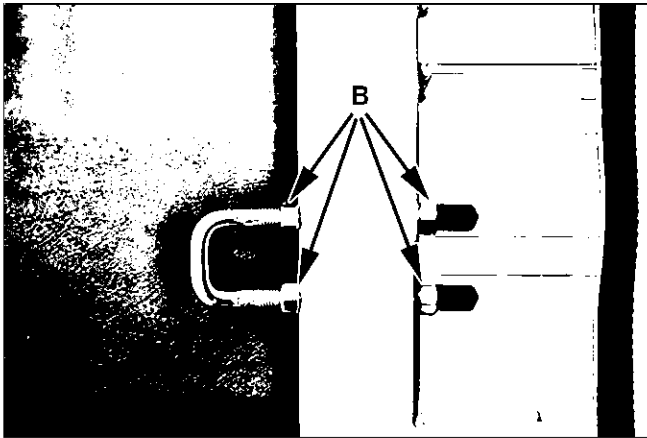

**Figure 8-20 Adjust Stall Divider**

### **8.8 DOORS, GATES AND RAMPS**

Cimarron trailers can be equipped with various styles of doors, gates and ramps. The following subsections describes the operation of each.

## Accessories

### 8.8.1 Livestock Center Gate

Livestock center gates are normally equipped with a slam latch. The gate is equipped with an inside and an outside release. Do not open center gates from the inside of the trailer with live animal(s) loaded.

### **⚠** WARNING

Animals are capable of inflicting serious injury or death to a human handler.

Do not open the center gate from inside the trailer with live animals loaded.

To open, disengage the vertical locking pin (A) by pulling it in an upward motion. Next, firmly grasp the vertical handle (B) from the interior of the trailer and pull, or pull on the exterior handle (C). See figures 8-21 and 8-22. If opening from the inside, swing the gate open to curb side and latch back against side wall.

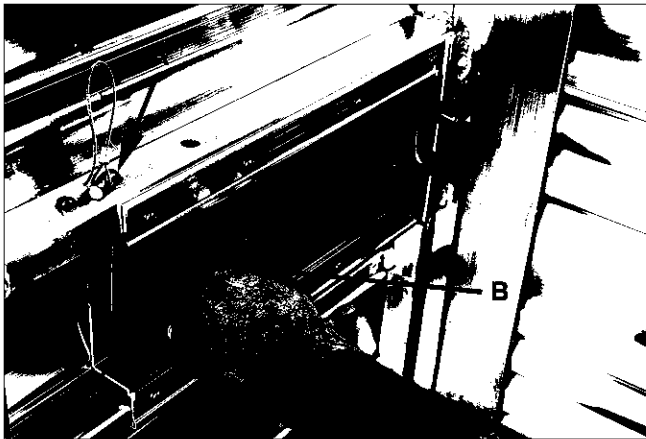

**Figure 8-21 Center Gate Lock Pin and Interior Handle**

## Accessories

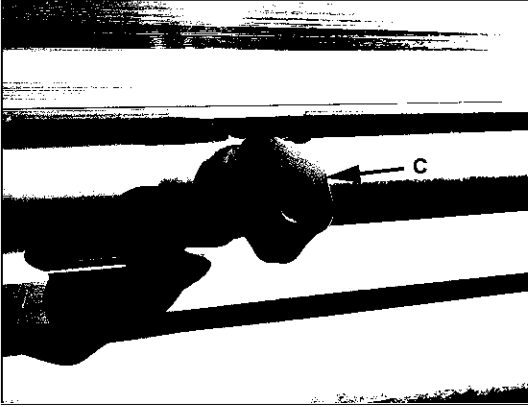
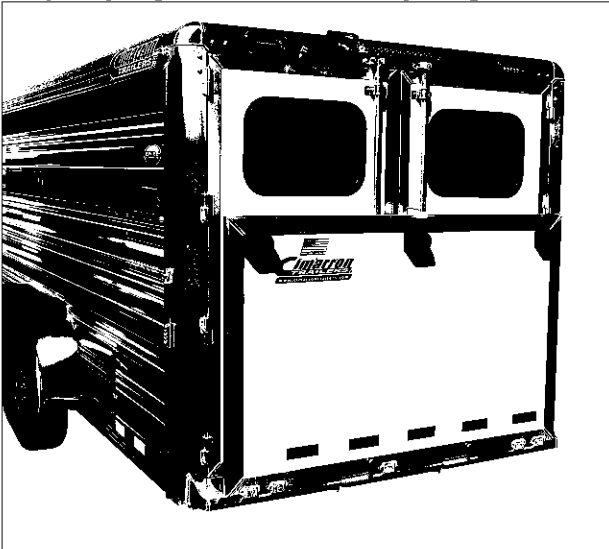

**Figure 8-22 Center Gate Exterior Latch Handle**

To close, simply swing the gate back to the closed position, thus engaging the slam latch. Engage locking pin (A) to secure gate. See figure 8-21.

### **8.8.2 Rear Ramp Over Rear Doors**

Your trailer may be equipped with a rear ramp over rear doors. See figure 8-23. The ramp is spring loaded to assist in opening and closing.



**Figure 8-23 Rear Ramp Over Rear Doors**

## Accessories

To open, pull up on latch (A) located on each side of the ramp and carefully lower the ramp. See figure 8-24 and 8-25.

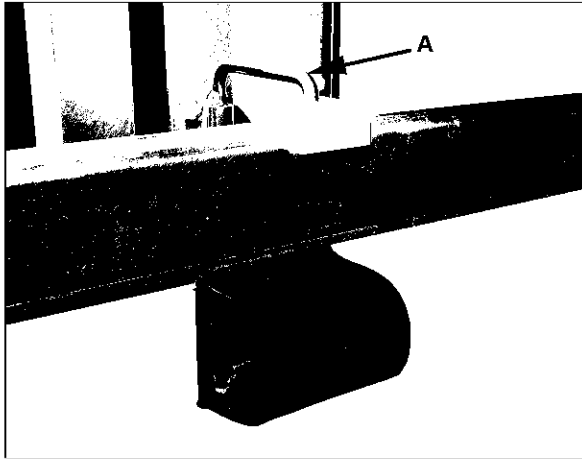

**Figure 8-24 Rear Ramp Over Latch**

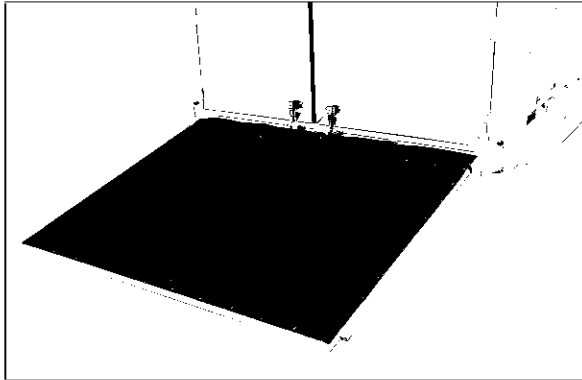

**Figure 8-25 Rear Ramp Over Rear Doors Lowered**

### **8.8.3 Full Height Side Ramp Door**

Your trailer may be equipped with a full height side ramp door. See figure 8-26. The ramp door is spring loaded to assist in opening and closing. Open latches and pull door to open.

## Accessories



**Figure 8-26 Full Height Side Ramp Door**

### **8.8.4 Rear Ramp And Storm Doors**

Your trailer may be equipped with rear ramp and storm doors. See figure 8-27. Open the top doors first, then open latches and pull the ramp to open. The ramp is spring loaded to assist in opening and closing.

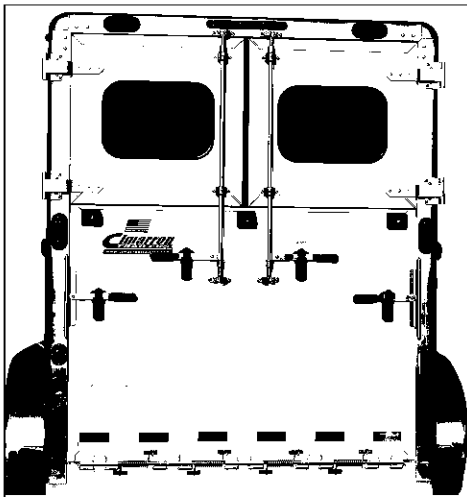

**Figure 8-27 Rear Ramp And Storm Door**

## Accessories

### 8.9 TACK ROOM

Your trailer may be equipped with a front walk-in tack room, rear permanent tack compartment or a rear fold away tack compartment. Do not store tack long term in the tack compartment due to condensation and mildew factors in diverse climates.

#### 8.9.1 Front Walk-in Tack Room

Located in front of the horse area with generally one access door on the curb or street side (dependent upon model). Front walk-in tack rooms are designed to store tack short term and must not be used for camping or overnight stay.

Only trailers equipped with a finished living quarters are designed to accommodate camping, sleeping and/or overnight stays, and are equipped with safety features such as, a vent and/or egress window (escape hatch). Walk-in tack rooms and unfinished living quarters are not equipped with these features.

You can die or be brain damaged by Carbon Monoxide.

- Do not operate a generator, portable grill, portable heater, portable lantern or portable stove inside the trailer.

### **WARNING**

Do not sleep in a trailer that is not equipped with a finished living quarters.

A trailer not designed with living quarters should only be used for transportation of its intended cargo.

#### 8.9.2 Rear Fold-Away Tack Compartment

Located in the rear, usually on the street side of the trailer, with the saddle tree removed, the tack compartment wall can be folded up to the outside wall. To begin this procedure, clear all remaining tack from the rear tack compartment, then remove the saddle tree (To remove, refer to Removable

## Accessories

Saddle Tree in this section). After removal, the saddle tree may be relocated to the front tack room. To fold-away the rear tack compartment wall, simply locate the securing pin(s) on the interior side of the center post at the back doors. Location of the pin(s) is dependent upon model. When pin(s) are located, free the wall by extracting spring loaded pin from the closed position. As wall becomes free, begin to fold forward and toward the outside wall. After partition is firmly against the outside interior wall, lock down the folding wall with the locking pin, located at the top of the partition. To restore the rear tack compartment to a usable position, simply reverse the above procedure. Make sure all pins are secured back in place and that everything is ready for travel. Moveable partition can be removed if desired by extracting the pins from the hinges on the wall.

### **8.9.3 Solid Rear Tack Compartment**

Located in the rear, usually on the street side of the trailer, the solid tack compartment cannot be removed. The saddle tree may or may not be removable depending upon the model. If the saddle tree is removable refer to removable saddle tree in this section, for instructions. If the saddle tree is mounted permanent it cannot be removed. The radius wall separating the rear tack compartment from the horse area is a solid wall to the floor and roof.

## Accessories

### 8.10 SADDLE TREE

Your trailer may be equipped with one or more saddle trees. Saddle trees consist of a post (A), saddle rack (B) and blanket pole (C). See figure 8-28. The number of saddle racks and blanket poles on a saddle tree post will vary depending on the model of your trailer. The post may be attached solid to the trailer or may be removable. Each saddle rack and blanket pole may be rearranged and height adjusted according to users individual needs. Do not store tack long term in tack compartment due to condensation and mildew factors in diverse climates.

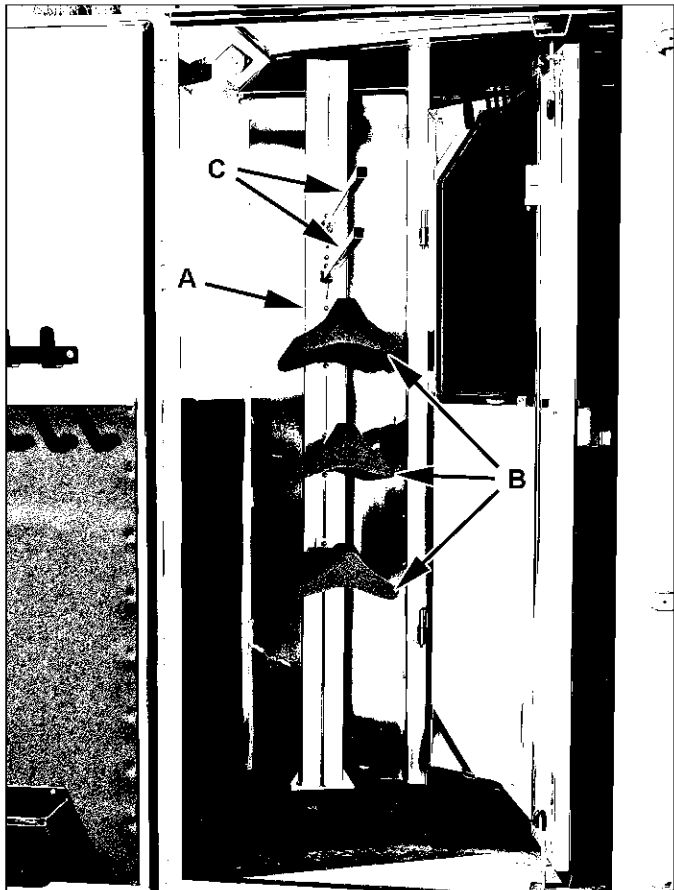
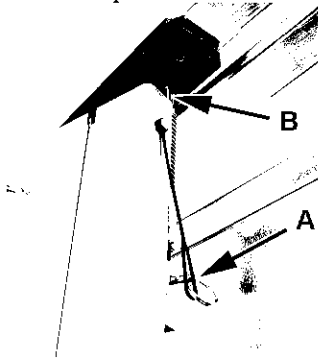

Figure 8-28 Saddle Tree

## Accessories

### 8.10.1 Removable Saddle Tree

To remove the saddle tree, first remove all saddles and tack from the saddle tree. Next, remove the safety detent pin (A) located on the side of the saddle tree post close to the top, by pulling the pin outward. This will release the saddle tree's spring loaded latch (B). See figure 8-29. Next, lift the saddle tree up, about 1 inch, compressing the upper latch spring, until the lower bracket will clear the floor receiver (C). See figure 8-30. Then tilt the bottom of the tree outwards toward the rear door opening and continue until removed. After removal, the saddle tree may be relocated to the front tack room, depending upon model. To replace the saddle tree, reverse the above procedure.



**Figure 8-29**  
**Top Saddle Post Pin & Latch**

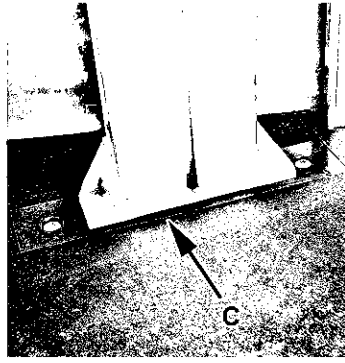
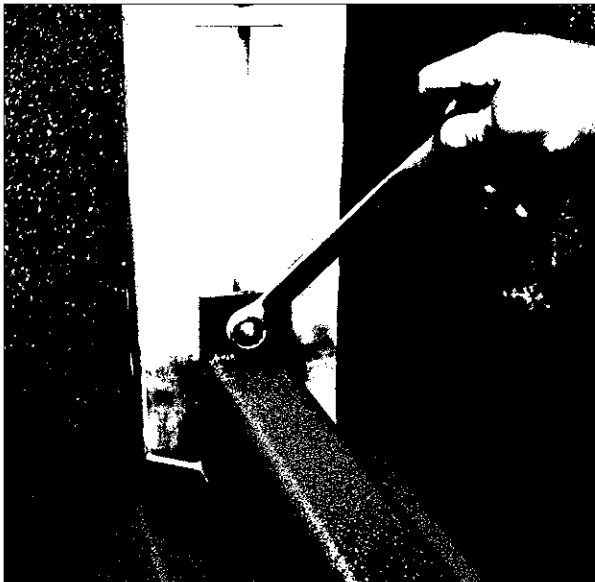

**Figure 8-30**  
**Bottom Saddle Post Floor Receiver**

## Accessories

### 8.10.2 Saddle Tree Adjustments

On most models, saddle racks and blanket poles are adjustable, height and position. To adjust the height of any or all saddle racks or blanket poles, simply loosen with a 5/8" wrench (do not remove) the acorn nuts that attach the rack or pole to the saddle tree post, until the rack or pole slides freely. See figure 8-31. Then, slide up or down to the new position and retighten. To reposition the saddle racks or poles on the saddle tree post, first remove the saddle tree from the trailer (refer to Removable Saddle Tree in this section). Lay the saddle tree on the ground and loosen (do not remove) the acorn nuts that attaches the rack or pole to the saddle tree post, until the rack or pole slides freely. Then slide up the pole until it slides free of the post. Rearrange racks and poles to fit your individual needs and reassemble. Be sure all acorn nuts are tight enough to support load while in transit. To avoid movement or slippage while in transit, tighten all acorn nuts to 40 ft. lbs. of torque.

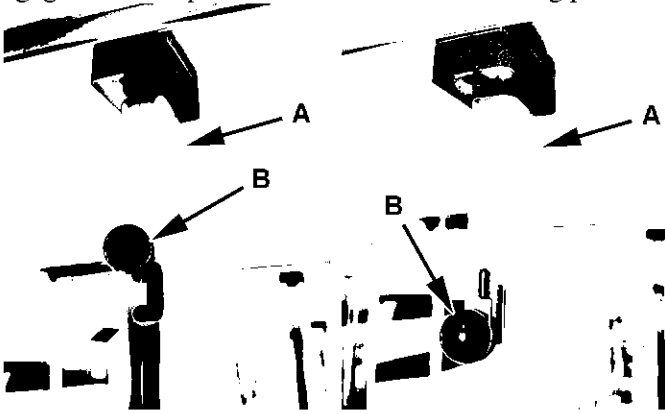

**Figure 8-31 Adjusting Saddle Rack Height**

## Accessories

### 8.11 REMOVABLE CENTER POST

To remove the center post, first remove all the attachments (dividers, head grills, gates, pen panels, etc.) from the center post (A). See figures 8-32 & 8-33. Next, move the spring-loaded A/R (Anti-Rattle) latch (B) from the “up” locked position to the “down” unlocked position. Once the A/R latch is moved to the “down” unlocked position, tilt the center post (A) forward and remove the post from the floor UHMW mounting pad. Stow away pens system appropriately. To replace, reverse procedure, being sure post is fully engaged in the top and bottom UHMW mounting pads.

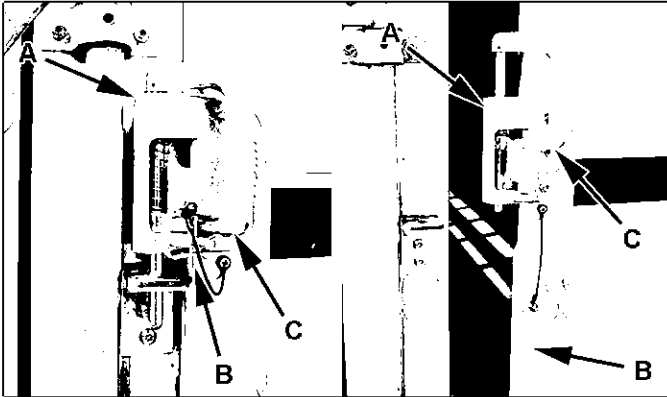

**Figure 8-32**  
**Center Post Installed**

**Figure 8-33**  
**Center Post Removed**

## 8.12 SLIDING GATE LATCH

Sliding gate latches are used on livestock trailers with sliding swing tailgates and center gates with the sliding gate option. **CAUTION** never stand directly in-line with the sliding gate opening during the animal loading and unloading process. Always stand to the side of opening. To open a sliding gate latch (A), remove the safety bail pin (B) from its closed position. See figures 8-34 and 8-35. Then, swing handle (C) over to vertical slot, lifting it up to top of slot and swing over into the retracted position. Once the handle is in the retracted position slide the gate open, take **CAUTION** to remaining out of the direct path of loading and unloading animals. To close reverse the procedure, being sure to return handle to latched position with safety bale pin in place.



*Figure 8-34*

*Sliding Gate Latch Closed*

*Figure 8-35*

*Sliding Gate Latch Opened*

## 8.13 LIVESTOCK TRAVELING CENTER GATE

Some Livestock trailers may be equipped with a traveling center gate(s). A traveling type center gate is suspended from the ceiling of trailer in a track system with rollers on each side, and can be moved from end to end of track, latching around side wall upright posts and special pockets with ease. Traveling gates should **ONLY** be repositioned when **NO** animal(s) are present. **DO NOT** open or move center gate(s) from the inside of the trailer with live animal(s) loaded.

## Accessories

### WARNING

Animals are capable of inflicting serious injury or death to a human handler.

Do not open the center gate from inside the trailer with live animals loaded.

This type of gate consists of an outer full perimeter frame with either a sliding or a swinging inner gate assembly. The outer full perimeter frame is latched and unlatched by four latches, one in each corner. To open latch (A), rotate the safety catch (B) up and around toward the center of the trailer. See figures 8-36 and 8-37. Next, move the handle (C) of the latch inward and upward rotating it a quarter of turn and then downward into its innermost holdback position. Repeat this procedure for each of the four latches. Reverse procedure to latch traveling center gate, being sure to check each latch is fully engaged around its accompanying side post. Be sure all four safety catches are fully engaged.

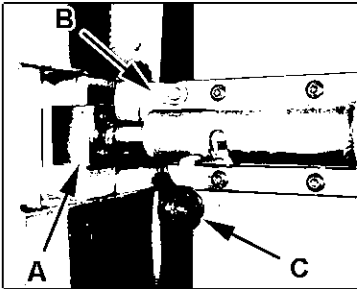

**Figure 8-36**

**Traveling Center Gate Closed**

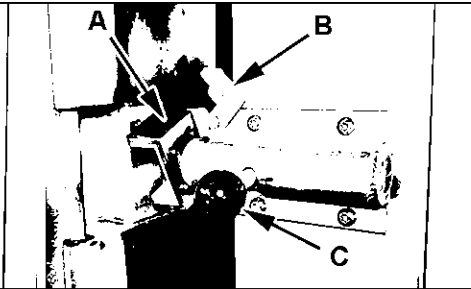

**Figure 8-37**

**Traveling Center Gate Open**

## Accessories

### 8.14 SMALL ANIMAL PENS

To open small animal pen(s) spring loaded latch, pull back on handle then rotate it 90 degrees down into the restrain groove. See figures 8-38 and 8-39. When latching reverse procedure being sure plunger is full engaged into catch. Spring loaded hold back(s) to restrain pen(s) in the loading and unload process are built into top section of center pen. To open, pull up and rotate over to pen to be held back and lower into correspond receiver hole in the top of pen. Reverse procedure to open. Be sure holdback is lowered back into its hold back hole.



*Figure 8-38*  
*Small Animal Pen Closed*

*Figure 8-39*  
*Small Animal Pen Opened*

### 8.15 SLIDEOUT

Your trailer may be equipped with a slideout room in the living quarters area. See figures 8-40, 8-41, 8-42, 8-43, 8-44 and 8-45. Be sure there is adequate clearance outside to extend the slideout room.

#### **WARNING**

Bystanders can be crushed by the slideout.

Keep people away from the slideout while extending and retracting.

Slide room operator's manuals are available on-line from HWH Corporation at [hwhcorp.com/cimarron.html](http://hwhcorp.com/cimarron.html) or from Liftco, Inc. at [liftcoproducts.com](http://liftcoproducts.com).

## Accessories

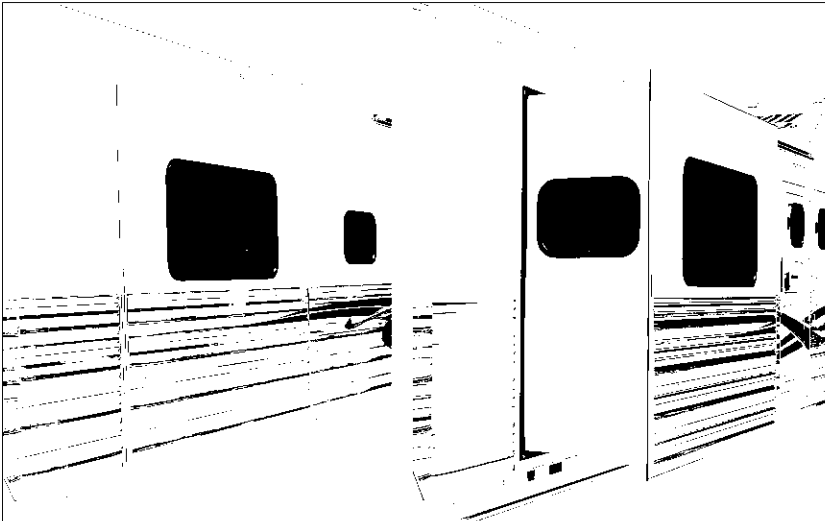

**Figure 8-40**

**HWH Slideout Retracted-Interior**

**Figure 8-41**

**HWH Slideout Extended-Interior**



**Figure 8-42**

**HWH Slideout Retracted-Exterior**

**Figure 8-43**

**HWH Slideout Extended-Exterior**

## Accessories



*Figure 8-44*

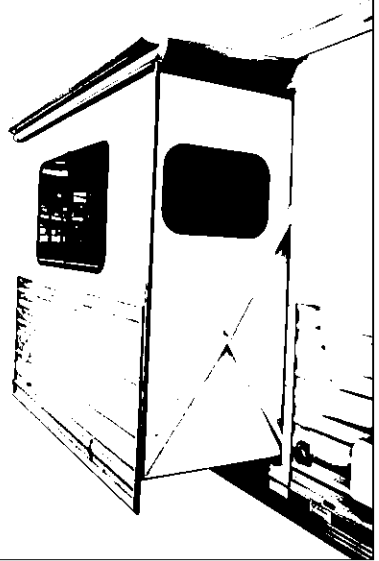

*Figure 8-45*

*Liftco Slideout Retracted-Interior Liftco Slideout Extended-Exterior*

# 9 INSPECTION, SERVICE & MAINTENANCE

## 9.1 INSPECTION, SERVICE & MAINTENANCE CHARTS

You must inspect, maintain and service your trailer regularly to insure safe and reliable operation. If you cannot or are unsure how to perform the items listed here, have your dealer do them. Note: In addition to this manual, also check the relevant component manufacturer's manual.

### **Inspection and Service Before Each Use**

Item	Inspection / Service	Manual Section Reference
<b>Breakaway Brakes</b> > Electric > Hydraulic	Check operation Check fluid level	Sections 4.2.1.5 & 4.2.2.5 Section 9.2.4.4
<b>Breakaway Battery</b>	Fully charged, connections clean	Sections 4.2.1.5 & 4.2.2.5
<b>Brakes, all types</b>	Check operation	Section 7.3
<b>Shoes and Drums</b>	Adjust	Section 7.2 & 9.2.4.2
<b>Brakes, Hydraulic - Vacuum Actuated</b>	Check gauge for proper vacuum of 18 In. Hg. (inches of mercury)	Section 9.2.4.4
<b>Coupler and Hitch Ball</b>	Check for cracks, pits, and flats. Replace w/ball & coupler having trailer GVW Rating. Grease. Check locking device & replace.	Section 4.2.1.1 Section 4.2.1.1 Section 9.2.5.1

## Inspection, Service & Maintenance

<b>Gooseneck Ball</b>	<p><b>Check for cracks, pits, and flats. Replace w/ball &amp; coupler having trailer GVW Rating.</b></p> <p><b>Grease.</b></p> <p><b>Check locking device &amp; replace when worn.</b></p>	<p><b>Section 4.2.2.1</b></p> <p><b>Section 4.2.2.1</b></p> <p><b>Section 9.2.5.2</b></p>
<b>Safety Chains &amp; Hooks</b>	<b>Check for wear and damage</b>	<b>Sections 4.2.1.4 &amp; 4.2.2.4</b>
<b>Tires</b>	<b>Check tire pressure when cold. Inflate as needed. Maintain maximum air pressure as stated on tire sidewall.</b>	<b>Sections 6.1 &amp; 9.2.9</b>
<b>Wheels - Lug Nuts (Bolts) &amp; Hub</b>	<b>Check for tightness</b>	<b>Section 6.1</b>
	<b>Tighten. For new and remounted wheels, check torque after first 10, 25 &amp; 50 miles of driving and after any impact</b>	<b>Sections 7.1 &amp; 9.2.12</b>

Inspection and Service each 3 Months or 3,000 Miles

Item	Inspection / Service	Manual Section Reference
<b>Body</b>		
> <b>Rubber mats and floor</b>	<b>Remove mats. Wash both sides. Wash floor</b>	<b>Section 9.2.2</b>
> <b>Hinges, Doors and Dividers</b>	<b>Inspect. Repair or replace damaged, worn or broken parts</b>	<b>Sections 5.3.1, 5.4.1 &amp; 9.2.2</b>
> <b>Cleaning</b>	<b>Wash complete exterior and interior of stall area</b>	<b>Section 9.2.2.1</b>

## Inspection, Service & Maintenance

Inspection and Service each 6 Months or  
6,000 Miles

Item	Inspection / Service	Manual Section Reference
Tires	Rotate @ 5,000 miles	Section 9.2.9
<b>Brakes, electric</b> > Magnets > Controller (in tow vehicle)	Check wear and current draw  Check power output (amperage) and modulation	See Mfr's Manual  See Controller Mfr's Manual
<b>Body</b> > Roof Vents > Windows > Door Hinges > Paddle Latches	Clean dirt buildup, lubricate hinges, slides and latches	Section 9.2.2  Section 9.2.3
Tires	Inspect tread and sidewalls thoroughly.  Replace tire when treads are worn, when sidewall has a bulge, or sidewall is worn	Section 9.2.9  Section 9.2.9
<b>Wheel Bearings, all axles</b>  <b>Axles up to 7,000 lb</b>  <b>Axles over 7,000 lb</b>	Check for free running and wobble.  Lube w/grease gun.  Repack with grease.	See axles mfr's manual  Section 9.2.11.1  Section 9.2.11.2

## Inspection, Service & Maintenance

Inspection and Service Each Year or 12,000 Miles

Item	Inspection / Service	Manual Section Reference
<b>Brakes, all types</b> > Shoes and drums	Check for scoring and wear. Replace per manufacturer's specifications	Section 9.2.4.1 See Brake Mfr's Manual
<b>Jack, Drop-leg</b>	Grease gears	See Jack Mfr's Manual
<b>Body</b> > Frame members > Welds  > Slide-out  > Roof Seal	Inspect all frame members, bolts & rivets. Repair or replace damaged, worn or broken parts.  Inspect all welds. Repair as needed  Clean dirt build-up. Lubricate per slide out mfg's recommendations.  Inspect and repair as needed	Section 9.2.1  Section 9.2.2.3  Section 9.2.2.4
<b>Wheel Rims</b>	Inspect for cracks & dents. Replace as needed.	Section 9.2.10
<b>Structure</b> > Axle Attachment Bolts	Check BY DEALER	Section 9.2.1

## 9.2 INSPECTION AND SERVICE INSTRUCTIONS

### 9.2.1 Axle Bolts, Frame, Suspension, & Structure

#### **WARNING**

Worn or broken suspension parts can cause loss of control and injury may result.

Have trailer professionally inspected annually and after any impact.

## Inspection, Service & Maintenance

To perform many of the inspection and maintenance activities, you must jack up the trailer. Figure 9-1 indicates the general areas where jacks and jack stands may be applied.

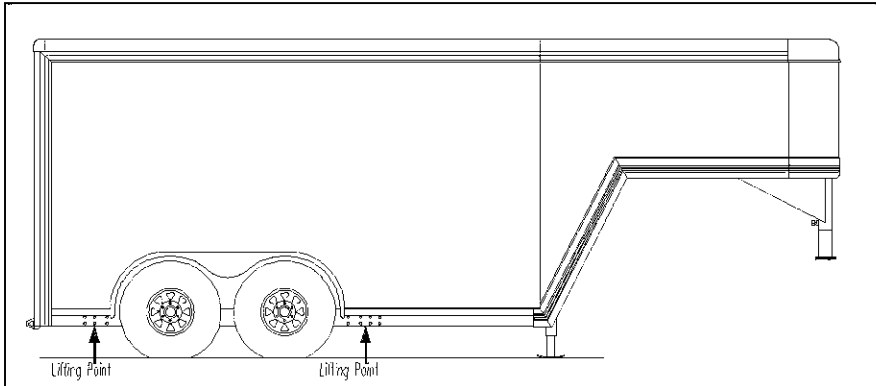

**Figure 9-1 Jacking Points**

When jacking and using jack stands, place them so as to clear wiring, brake lines, and suspension parts (springs, torsion bars, etc.). Place jacks and jack stands on the supporting structure to which the axles are attached, as close to outside main frame as practical.

### **⚠ WARNING**

Never crawl under your trailer unless it is on firm and level ground and resting on properly placed and secured jack stands.

## **9.2.2 Trailer Body**

### **9.2.2.1 Cleaning**

Because the trailer floor receives the most abuse, it will most likely corrode before any other part of the structure. This is particularly true for horse and livestock trailers, having floors subjected to urine and manure. The urine and manure are corrosive to the aluminum flooring and other structural parts of the trailer.

## Inspection, Service & Maintenance

Remove the rubber mats from the floor of the trailer, and wash them, at least every three months. Using a power washer and a neutral ph automotive detergent solution, wash both sides of the rubber mat, as well as the floor and interior walls of the trailer. Rinse the rubber mat and the trailer floor and walls completely. Rinse, rinse, and rinse some more, it is very important to expel all acid residues, in order to provide maximum protection to the aluminum floor. Be sure the rubber mat and trailer floor are completely dry before replacing the rubber floor mat.

**HINT:** Before replacing rubber mats sprinkle a box of baking soda over the dry floor. The baking soda will help to neutralize the corrosive acids in the urine and manure. It will also help control odors.

Washing the exterior of your trailer regularly is the easiest way to maintain its new appearance. It is recommended to wash the exterior at least every three months, with cool or lukewarm water and a neutral ph automotive detergent solution. Numerous cleaning products are available from your local automotive supply store.

Never use strong house hold detergents or soap, such as dish washing or laundry liquid. These products can discolor and spot the painted and natural aluminum surfaces of your trailer. **Hint: DO NOT USE “Dawn®”** brand dish washing detergent, it can cause permanent tea colored stains on natural aluminum surfaces.

Never wash a trailer that is “hot to the touch” or during exposure to strong, direct sunlight. Always use a clean sponge, carwash mitt, or truck type soft brush and pole with plenty of water for best results. Dry the trailer with a chamois or soft terry cloth towel in order to eliminate water spotting.

It is especially important to wash the trailer regularly when used during the winter months, as dirt and road salt are difficult to remove and cause damage to the trailer. Immediately remove items such as gasoline, diesel fuel, bird droppings and insect deposits because they can cause permanent damage to the finish over time. Flush the complete underside of your trailer frequently. Keep body and door drain holes free from packed dirt.

## Inspection, Service & Maintenance

If your trailer is equipped with rubber floor or ramp mats, **DO NOT USE** rubber, plastic and vinyl protective products on the mats, as they cause the mat to become extremely slippery.

As with all metals, natural raw aluminum over time will oxidize and tarnish, changing from an even silver white to a dark gray somewhat streaked appearance. To remove this aluminum oxide from the surface and bring back your trailer's NEW appearance, periodically, your aluminum trailer may need to be acid washed. Acid washing should be done by experienced personnel at your local dealership or truck wash. The time frame between acid washes varies greatly from location to location. Environmental issues such as humidity, chemical exposures, road salts, and temperature can vary the time between acid washes greatly, it all depends on the general appearance of your specific trailer. But as a Rule Of Thumb, most aluminum trailers need to be acid washed about every two years.

### 9.2.2.2 Fasteners and frame members

Inspect all of the fasteners and structural frame members for bending and other damage, cracks, or failure. Repair or replace any damaged fastener and repair the frame member. If you have any questions about the condition or method of repair of fasteners or frame members, get the recommendation of, or have the repair done by, your dealer.

The various fastener types used on your trailer are:

Bolts, which are used mainly for attaching accessories and gate hinges to the trailer body;

VHB Tape, which is used to attach the door and sidewall skins of the body to each other, and to the frame of the trailer; and

Huck Bolts are used at various locations on the sub-frame. Huck bolts are not user serviceable. If you detect a loose huck bolt fastener, do not tow the trailer. Call your Cimarron trailer dealer for instructions.

## Inspection, Service & Maintenance

### WARNING

Broken or damaged fasteners or welds can cause injury or damage to trailer and contents.

Inspect for, and repair all damaged parts at least once a year.

#### 9.2.2.3 Welds

All welds can crack or fail when subjected to heavy loads, extreme vibration, or movement of cargo that was not properly tied to prevent movement. Any time that you know or suspect that the trailer has been subjected to heavy loads, extreme vibration or movement of cargo, immediately inspect the welds and fasteners for damage. To prevent severe damage to your trailer, inspect all of the welds for cracks or failure at least once a year.

### WARNING

Improper weld repair will lead to early failure of the trailer structure and can cause serious injury or death.

Do not repair cracked or broken welds unless you have the skills and equipment to make a proper repair. If not, have the welds repaired by your dealer.

#### 9.2.2.4 Roof Seal

All roof sealants can crack or fail when subjected to extreme vibration, prolonged exposure to ultra violet radiation, extreme heat or extreme cold for prolong periods. Any time that you know or suspect that the trailer has subjected to these conditions, immediately inspect the roof seal for damage. To prevent severe damage to your trailer and contents, inspect the roof seal for cracks, adhesion or failure at least once a year.

To repair roof sealant, manufacturer insists you only use, **Dow-Corning 791 neutral cure silicone sealant**. The use of this specific sealant is required to maintain your roof seal integrity for adhesion and elasticity

## Inspection, Service & Maintenance

reasons. If you cannot find this sealant locally, contact your dealer or Cimarron Trailers, at 405-222-4800 for a supply of this specific sealant.

### **NOTICE**

**Although roof seams are sealed, trailer is not guaranteed waterproof. Precautions should be made to protect valuable cargo. Failure to do so may result in water damage to contents.**

**Inspect for and repair all damaged sealant at least once a year**

### **9.2.3 Door Hinges**

Lubricate all door hinges with grease every 6 months or 6,000 miles. See figure 9-2.

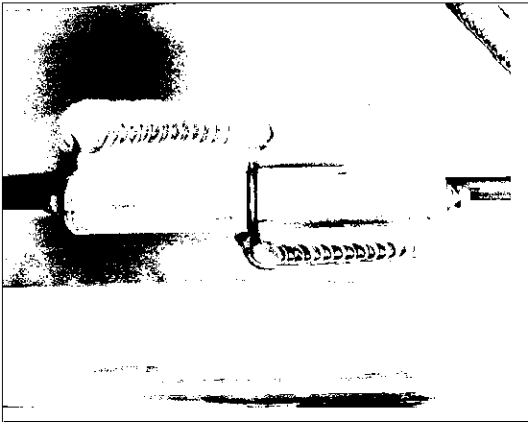

**Figure 9-2 Lubricate Door Hinges**

## 9.2.4 Trailer Brakes

### 9.2.4.1 Brake shoes and drums

Properly functioning brake shoes and drums are essential to ensure safety. You must have your dealer inspect these components at least once per year, or each 12,000 miles.

The brake shoes must be adjusted after the first 200 miles of use, and each 3,000 miles thereafter. Some axles are fitted with a brake mechanism that will automatically adjust the brakes shoes when the trailer is “hard braked” from a rearward direction. Read your axle and brake manual to see how to adjust your brakes. If you do not have this manual, call Cimarron Trailers, Inc. at 405-222-4800 for a free copy.

### 9.2.4.2 Manually adjusting brake shoes

Most braking systems are not automatically adjusted by hard stopping. Refer to your axle and brake manual to see how to adjust your brakes. If you do not have this manual, call Cimarron Trailers, Inc. at 405-222-4800 for a free copy.

### 9.2.4.3 Brakes, Electric

Two different types of electric brakes may be present on the trailer: an emergency electric breakaway system, which acts only if the trailer comes loose from the hitch and the breakaway pin is pulled. The other brake is an electric braking system that acts whenever the brakes of the tow vehicle are applied.

## **Breakaway Brake**

- **Breakaway Battery**

This battery supplies the power to operate the trailer brakes if the trailer uncouples from the tow vehicle. Be sure to check, maintain and replace the battery according to the battery manufacturer’s instructions. The breakaway battery is equipped with an inline battery charger, in order for this charger to function, the trailer must receive 12 volt auxiliary power from the tow vehicle.

## Inspection, Service & Maintenance

- Breakaway Switch

This switch causes the breakaway battery to operate the electric brakes if the trailer uncouples from the tow vehicle.

To check for proper functioning of the switch, battery and brakes, you must pull the pin from the switch and confirm that the brakes apply to each wheel. You can do this by trying to pull the trailer with the tow vehicle, after pulling the pin. The trailer brakes may not lock, but you will notice that a greater force is needed to pull the trailer.

### WARNING

If electric breakaway brakes do not operate when trailer is uncoupled from the tow vehicle, death or serious injury can occur.

Check emergency breakaway brake system BEFORE each tow.

- Tow Vehicle Operated Electric Brakes

The electric brakes that operate in conjunction with the tow vehicle brakes must be “synchronized” so that braking is properly distributed to the tow vehicle brakes and the trailer brakes. For proper operation and synchronization, read and follow the axle/brake and the brake controller manufacturer's instructions. If you do not have these instructions, call Cimarron Trailers, Inc. at 405-222-4800 for a free copy.

- Magnets for all Electric Brakes

To make certain an electrically-operated braking system will function properly, you must have your dealer inspect the magnets at least once a year, or each 12,000 miles. See the brake manual for wear and current inspection instructions.

#### 9.2.4.4 Brakes, Hydraulic (air or electric operated)

If your trailer has hydraulically-operated brakes, they function the same way the hydraulic brakes do on your tow vehicle. The hydraulic braking system must be inspected by a dealer, at least as often as the brakes on the tow vehicle, but no less than once per year. This inspection includes an assessment of the condition and proper operation of the wheel cylinders, brake shoes, brake drums and hubs.

## Inspection, Service & Maintenance

You must check the fluid level in the master cylinder reservoir at least every three months. If you tow your trailer an average of 1,000 miles per month in a hot and dry environment, you must check the brake fluid level once a month. The brake fluid reservoir is located on the tongue of the trailer or near the gooseneck. Fill with DOT 3 brake fluid.

### WARNING

If the vacuum gauge in tow vehicle is not at or above 18 in. Hg. (inches of mercury), damage to the brake system will result and the brakes may become inoperable.

- **Air Pressure-Operated Hydraulic**

Air/hydraulic braking systems are typically used when the tow vehicle has a diesel engine. The tow vehicle has an air compressor that routes the air to an air/hydraulic mechanism, which sends brake fluid to the wheel cylinders.

The air pressure gauge in your tow vehicle indicates the current air pressure. See your tow vehicle manual for the proper air pressure.

- **Electrical-Operated Hydraulic**

Electric/hydraulic braking systems, which are mounted on the trailer, use a small electrically-driven pump to generate hydraulic pressure, which operates the brake cylinders. Like electrical brakes, an electric/hydraulic braking system is operated by an electrical signal from the tow vehicle.

## **9.2.5 Trailer Connection to Tow Vehicle**

### **9.2.5.1 Coupler and ball**

The coupler on the trailer connects to the ball attached to the hitch on the tow vehicle. The coupler, ball and hitch transfer the towing forces between the tow vehicle and the trailer. Before each tow, coat the ball with a thin layer of automotive bearing grease to reduce wear and ensure proper operation; and check the locking device that secures the coupler to the ball for proper operation.

## Inspection, Service & Maintenance

See the coupler manufacturer's manual for other inspection and maintenance activities. If you do not have this manual, call Cimarron Trailers, Inc. at 405-222-4800 for a free copy.

If you see or feel evidence of wear, such as flat spots, deformations, pitting or corrosion, on the ball or coupler, immediately have your dealer inspect them to determine the proper action to prevent possible failure of the ball and coupler system. All bent or broken coupler parts must be replaced before towing the trailer.

The coupler handle lever must be able to rotate freely and automatically snap into the latched position. Oil the pivot points, sliding surfaces, and spring ends with SAE 30W motor oil. Keep the ball pocket and latch mechanism clean. Dirt or contamination can prevent proper operation of the latching mechanism.

When replacing a ball, the load rating must match or exceed the GVWR of the trailer.

### 9.2.5.2 Gooseneck

The gooseneck receiver on the trailer connects to a hitch-mounted ball on the towing vehicle. The receiver, ball and hitch transfer the towing forces between the tow vehicle and the trailer. Before each tow, coat the ball with a thin layer of automotive bearing grease to reduce wear and ensure proper operation; and check the locking device that secures the receiver to the ball for proper operation.

See the gooseneck ball receiver manufacturer's manual for other inspection and maintenance activities. If you do not have a manual for the receiver, call Cimarron Trailers, Inc. at 405-222-4800 for a free copy.

If you see or can feel evidence of wear, such as flat spots, pitting or corrosion, on the ball or receiver, immediately have your dealer inspect them to determine the proper action to prevent possible failure of the ball and receiver system.

When replacing a ball, the load rating must match or exceed the GVWR of the trailer.

## Inspection, Service & Maintenance

### **9.2.6 Landing Leg or Jack**

If a grease fitting is present, you must use a grease gun to lubricate the jack mechanism. Grease the gears in the top of hand-cranked jacks once a year, by removing the top of the jack and pumping or hand packing grease into the gears.

### **9.2.7 Lights and Signals**

Before each tow, check the trailer taillights, stoplights, turn signals and any clearance lights for proper operation.

#### **WARNING**

Improper operating taillights, stoplights and turn signals can cause collisions.

Check all lights before each tow.

### **9.2.8 Accessory Battery**

Your trailer may be outfitted with an accessory battery that operates lighting, electric landing gear, slide-outs or other accessories. An accessory battery may be kept charged either by the tow vehicle or by the generator or shore power. See the manual for the accessory battery. Trailers with accessory batteries are wired for a charge line from the tow vehicle. Your tow vehicle must have 12 volt auxiliary power to the trailer plug for the charge system to function. At the accessory battery the auxiliary power charger line will have an in-line 30 amp breaker. Check and replace as necessary.

A disconnect switch may be provided to disconnect the accessory battery when you do not plan to be using the trailer for an extended period, such as seasonal storage. If there is no disconnect switch, then remove the cables from the battery terminals.

The accessory battery must be kept in a charged condition during storage. The battery could freeze and break if it becomes discharged.

# Inspection, Service & Maintenance

## 9.2.9 Tires

Before each tow, be sure the tire pressure is at the value indicated on the Certification / VIN label. Tire pressure must be checked while the tire is cold. Do not check the tire pressure immediately after towing the trailer. Allow at least three hours for a tire to cool, if the trailer has been towed for as much as one mile. Replace the tire before towing the trailer if the tire treads have less than 2/32 inch depth or the telltale bands are visible.

A bubble, cut or bulge in a side wall can result in a tire blowout. Inspect both side walls of each tire for any bubble, cut or bulge; and replace a damaged tire before towing the trailer.

### **WARNING**







Worn, damaged or under-inflated tires can cause loss of control, resulting in damage, serious injury and possibly death.

Inspect tires before each tow.

The tire air pressure for trailer tires **MUST** be kept at be the cold inflation pressure indicated on the tire sidewall. The following chart lists the most common tires used on Cimarron Trailers, and includes tire size, load range, capacity each, cold inflation pressure and combined capacity for four tires.

### **Cimarron Trailers Standard Tire, Capacity Chart**

Tire Size	Load Range	Capacity Ea.	Infl. Press.
ST225/75R15"	D	2540#	65 psi cold
ST235/85R16"	E	3520#	80 psi cold
ST235/85R16"	G	4080#	110 psi cold
235/75R17.5"	H	6005#	125 psi cold
245/70R17.5"	J	6005#	125 psi cold
265/70R19.5"	G	5205#	115 psi cold

<b>Tire Wear Diagnostic Chart</b>			
<b>Wear Pattern</b>		<b>Cause</b>	<b>Action</b>
	<b>Center Wear</b>	Over Inflation	Adjust pressure to particular load per tire catalog
	<b>Edge Wear</b>	Under Inflation	Adjust pressure to particular load per tire catalog
	<b>Side Wear</b>	Loss of camber or overloading	Make sure load doesn't exceed axle rating. Align at alignment shop
	<b>Toe Wear</b>	Incorrect toe-in	Align at alignment shop
	<b>Cupping</b>	Out-of-balance	Check bearing adjustment and balance tires
	<b>Flat Spots</b>	Wheel lockup & tire skidding	Avoid sudden stops when possible and adjust brakes

**Figure 9-3 Tire Inspection and Wear Diagnostic Chart**

### **9.2.10 Wheel Rims**

If the trailer has been struck, or impacted, on or near the wheels, or if the trailer has struck a curb, inspect the rims for damage (i.e. being out of round); and replace any damaged wheel. Inspect the wheels for damage every year, even if no obvious impact has occurred.

### **9.2.11 Wheels, Bearings and Lug Nuts**

A loose, worn or damaged wheel bearing is the most common cause of brakes that grab.

## Inspection, Service & Maintenance

To check your bearings, jack trailer and check wheels for side-to-side looseness. If the wheels are loose, or spin with a wobble, the bearings must be serviced or replaced.

### 9.2.11.1 Wheel bearings (Axles up to 7,000 lb)

The bearings must be lubricated every 6 months or 6,000 miles to insure safe operation of your trailer. See figure 9-4.

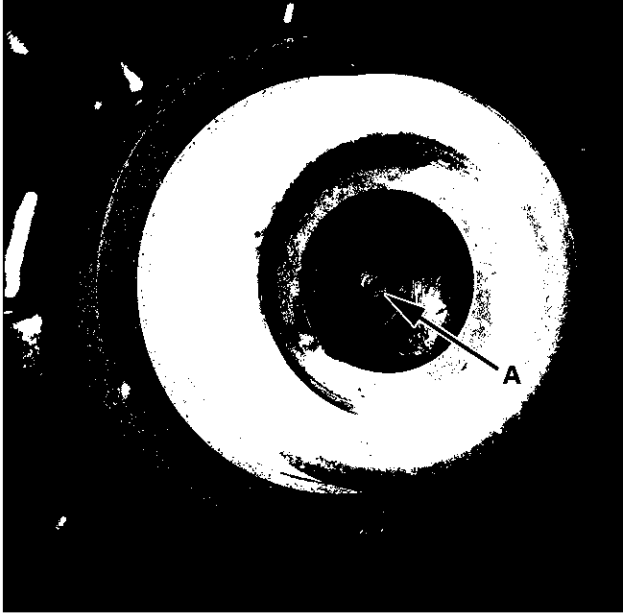

**Figure 9-4 E-Z Lube® Axle Wheel Bearing**

- Remove the rubber plug from the grease cap.
- Place grease gun on grease zerk (A).
- Pump grease gun until new grease begins to appear.

Hint: Use a different color of grease each time so you will know when the new grease begins to appear.

- Install rubber plug on grease cap.

Refer to the axle manufacturer's manual for additional service information. If you do not have this manual, call Cimarron Trailers, Inc. at 405-222-4800 for a free copy.

## Inspection, Service & Maintenance

### 9.2.11.2 Wheel bearings (Axles over 7,000 lb)

The bearings must be lubricated every 6 months or 6,000 miles to insure safe operation of your trailer. Remove the hub and repack the wheel bearings. Refer to the axle manufacturer's manual for additional service information. If you do not have this manual, call Cimarron Trailers, Inc. at 405-222-4800 for a free copy.

### 9.2.12 Lug Nuts (Bolts)

Lug nuts are prone to loosen right after a wheel is mounted to a hub. When driving on a remounted wheel, check to see if the lug nuts are tight after the first 10, 25 and 50 miles of driving and before each tow thereafter.

#### **WARNING**

Lug nuts are prone to loosen after initial installation, which can lead to death or serious injury.

Check lug nuts for tightness on a new trailer or when wheel(s) have been remounted after the first 10, 25 and 50 miles of driving.

#### **WARNING**

Metal creep between the wheel rim and lug nuts will cause rim to loosen and could result in a wheel coming off, leading to death or serious injury.

Tighten lug nuts before each tow.

Tighten the lug nuts to the proper torque for the axle size on your trailer, to prevent wheels from coming loose. Use a calibrated torque wrench to tighten the fasteners. Over-tightening will result in breaking the studs or permanently deforming the mounting stud holes in the wheels.

5. Remove all excess paint, oil and grease from mounting surfaces.
6. Start all lug nuts by hand to prevent cross threading.
7. Tighten lug nuts in the sequence shown in the “Lug Torque Sequence” figure 9-5.
8. Tighten lug nuts in three stages as shown in figure 9-6.

## Inspection, Service & Maintenance

9. Check and retorque after the first 10, 25 and 50 miles of driving and before each tow thereafter.

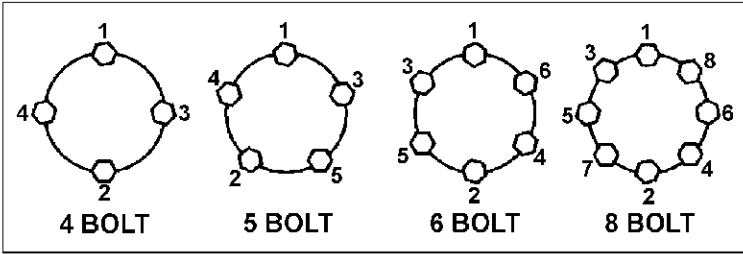

**Figure 9-5 Lug Torque Sequence**

<b>Lug Nut Torque – Aluminum Wheels</b>			
<b>Stud Size</b>	<b>1st Stage</b>	<b>2nd Stage</b>	<b>3rd Stage</b>
1/2 Inch	60 ft. lbs.	90 ft. lbs.	120 ft. lbs.
9/16 Inch	490 ft. lbs.	120 ft. lbs.	140 ft. lbs.
5/8 Inch	100 ft. lbs.	140 ft. lbs.	160 ft. lbs.

**Figure 9-6 Aluminum Wheel Torque Values**

NOTE: Due to custom manufacturing changes and requirements, torque markings or labels on parts, wheels, lug nuts or wheel studs, take precedence over the above chart for standard assemblies.

# 10 ELECTRICAL DIAGRAMS

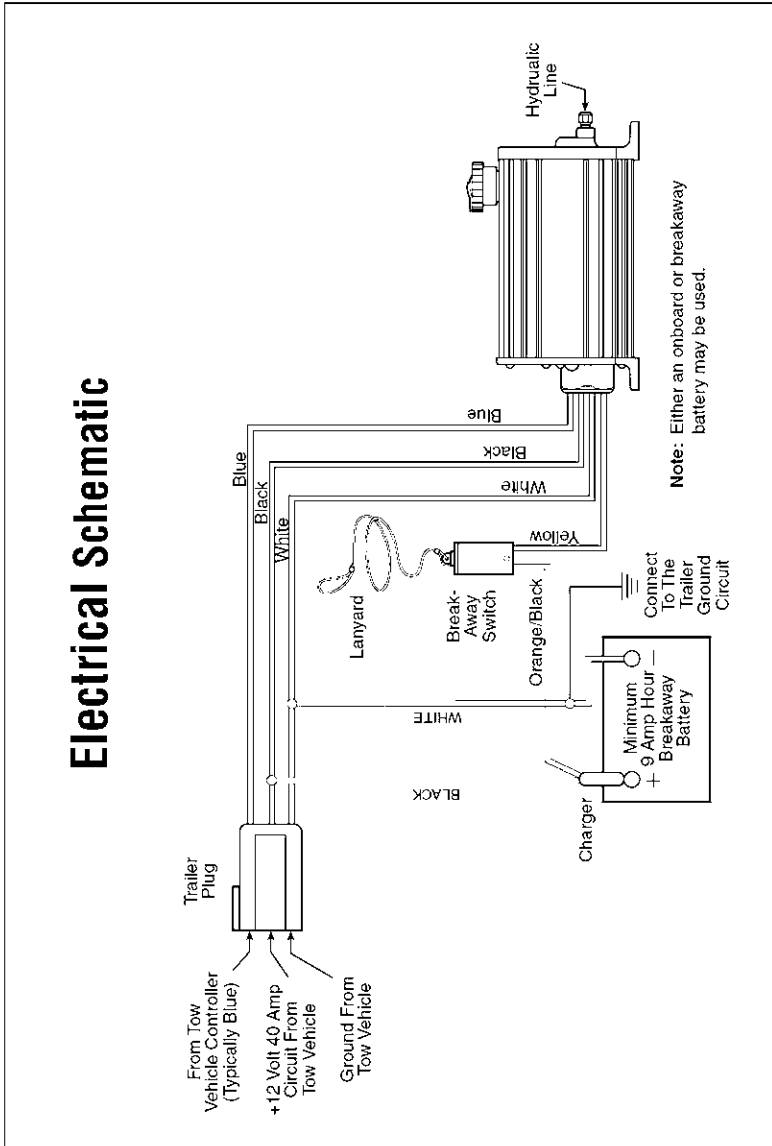

**Figure 10-1 Electric / Hydraulic Brake Actuator Schematic**

# Electrical Diagrams



## STANDARD WIRING SCHEMATIC

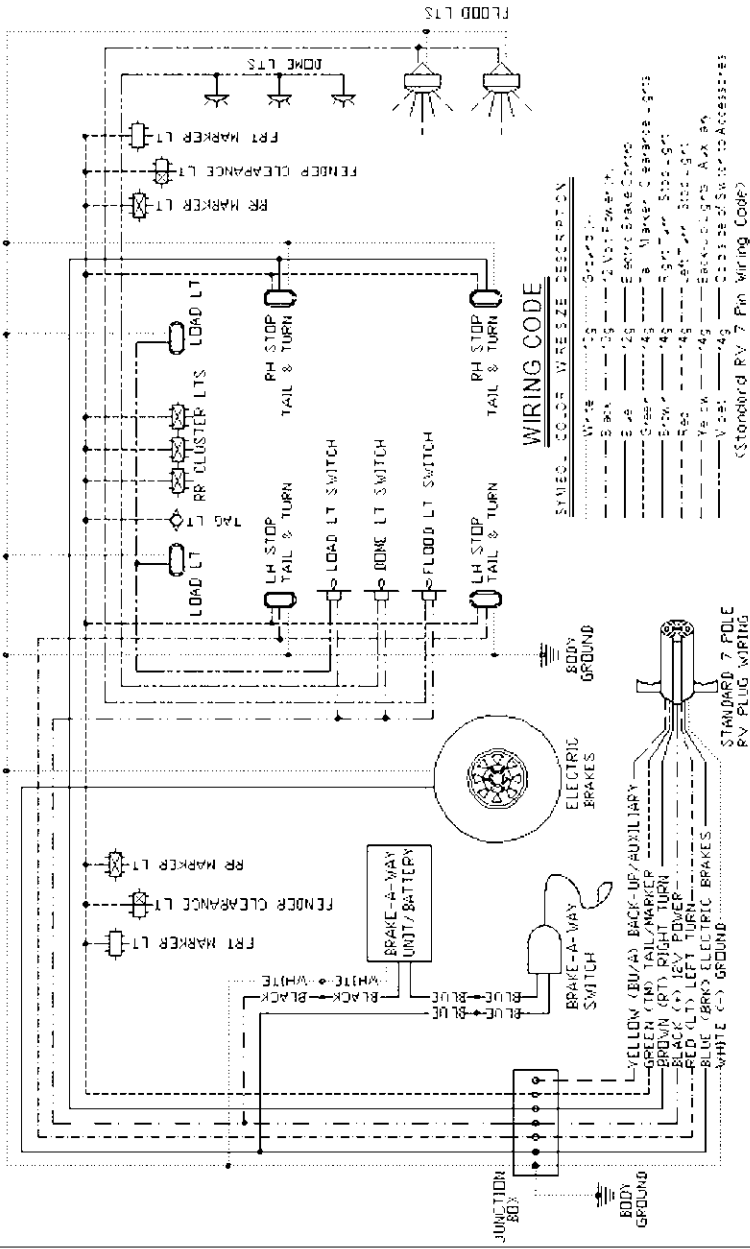

Figure 10-2 Standard Wiring Schematic



# Electrical Diagrams



## STANDARD RV 7 PIN ELECTRICAL CONNECTOR

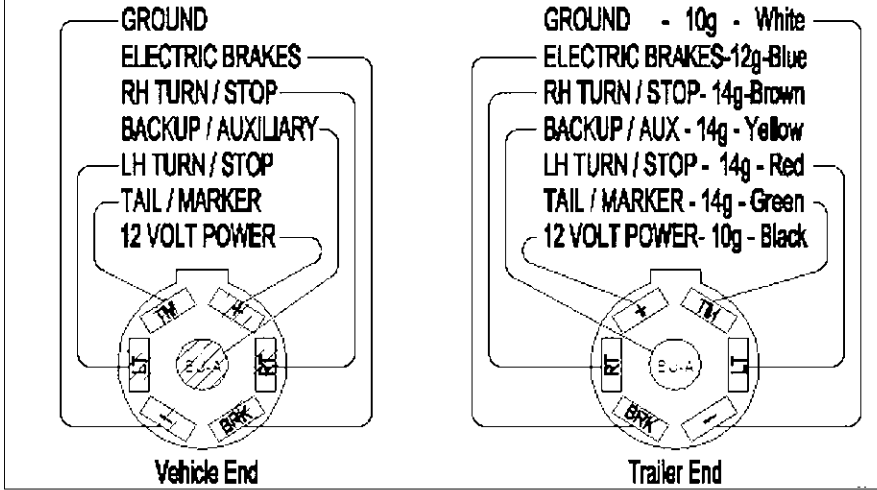

**Figure 10-4, 7 Pin Electrical Connector**

# 11 WARRANTY INFORMATION

8 Year Warranty effective starting with 2014 model year trailers.



Cimarron Trailers, Inc, (**Manufacturer**) warrants to the original purchaser (**the Purchaser**) that the Cimarron Trailer (**the Product**) purchased shall be free of defects in materials and workmanship attributable to manufacturer, subject to the limitation and exclusions described below. The warranties described below will hereafter be identified as “this Warranty”. The term of this Warranty described below begins from the date of the original purchase of product. Manufacturer warrants that the particular components of its trailer product will be free from defects in materials and workmanship for the warranty period specified below corresponding to the particular component. Manufacturer's determination of whether the Product has been abused or misused by the Purchaser is final and binding on Purchaser regarding Purchaser's right under this warranty.

**TO ACTIVATE THIS WARRANTY, this warranty shall be signed by Dealer and Original Purchaser and mailed to Cimarron Trailers, Inc., Warranty Department, PO Box B, Chickasha, OK 73023 within thirty (30) days of date of purchase. IF THIS SIGNED WARRANTY IS NOT POST MARKED BY THE THIRTIETH DAY AFTER PURCHASE, ALL WARRANTIES WHETHER EXPRESSED OR IMPLIED SHALL BE NULL AND VOID.**

**Structural – 8 years recreational; 1 year commercial.** Manufacturer warrants that the structural components of the trailer main frame assembly, consisting of the bottom rails, floor cross members, side posts, side and roof rail extrusions, hitch and sub frame only, will be free of defects in materials and workmanship attributable to manufacturer for eight (8) years from the date of original purchase. If manufacturer's trailer product is used for a commercial purpose, manufacturer warrants that the structural

## Warranty Information

components of the trailer main frame assembly shall be free from defects in materials and workmanship attributable to manufacturer for one (1) year from the date of original purchase.

### **Body and Hardware – 3 years recreational; 1 year commercial**

Manufacturer warrants that the non-structural trailer components, including without limitation the manufactured doors, hinges, gates, divider parts, attachments, and any options manufactured by manufacturer (all of the foregoing being referred to as “Body and Hardware”) will be free of defects in materials and workmanship attributable to manufacturer for three (3) years from the date of original purchase if manufacturer’s trailer product is used for ordinary, normal and proper recreational use. If manufacturer’s trailer product is used for a commercial purpose, manufacturer warrants that the Body and Hardware shall be free from defects in materials and workmanship attributable to manufacturer for one (1) year from the date of original purchase.

**Sealants – 1 year.** Manufacturer warrants that a trailer’s roof sealants and caulking will be free of defects in material and workmanship attributable to manufacturer one (1) year from the date of original purchase. After one (1) year, sealants and caulking are a maintenance item.

**Other Manufacturers’ Warranties.** Manufacturer passes through to the purchaser all warranties from all third party manufacturers for all products, attachments, and parts manufactured by those third-parties and incorporated into or attached to manufacturer’s trailer products. Purchaser is directed to the warranty information supplied by the other manufacturer that accompanies purchaser’s trailer for the description of their warranty, the time period and any exclusions to their warranties. Items manufactured by third parties that are sold as part of your trailer include but are not limited to: Living Quarter packages and all related components, roof material, axles, axle components, tow in and tow out on axles, camber on axles, tires, rims, air conditioners, generators, awnings, electrical jacks, landing gear, couplers, batteries, and ramp door springs.

**Warranty Exclusions.** This warranty excludes: (1) repair or replacement of items subject to wear and tear or that must be maintained by purchaser due to the stress of normal operations and wear and tear, including but not limited to, bearings, brakes, brake linings, hoses, tires, bearing seals,

## Warranty Information

hinges; (2) defacing, scratching, dents, chips, tears not caused by manufacturer or damage caused by abuse or misuse of the trailer by man or animal, abuse or misuse of any component parts, by the environment or by acts of God; (3) damage caused by loads in excess of Gross Vehicle Weight Rating stated on the certification plate; (4) paint deterioration due to wear and paint damage from decals, graphics, road elements, improper wash solvents, salt, sand and weather; (5) damage to floor due to failure to maintain properly; (6) damage due to use of aluminum brighteners, etching acids, caustics cleaning agents, fertilizers, cement, etc.; (7) damage caused by improper hitch ball, tow vehicle hook up, or towing with a truck or other vehicle rated higher than two times the GVWR of the trailer (unless the towing vehicle is "air ride" equipped); (8) damages to any tow vehicle wiring; (9) damages caused by failure to check and torque lug nuts properly resulting in any loose lug nuts; (10) damage to contents of any trailer product, regardless of cause.

**Warranty Void Due to Unauthorized Repairs and Accessories.** THIS WARRANTY WILL BE VOIDED BY ANY REPAIR OR MODIFICATIONS TO THE PRODUCT, OR ADDITION OF PRODUCT ACCESSORIES BY ANYONE OTHER THAN AN APPROVED CIMARRON DEALER. Manufacturer will not be responsible for work performed by anyone other than the manufacturer.

**Limitations of Damages.** Manufacturer specifically disclaims any and all liability under this warranty for special, incidental, indirect or consequential damages, which include but are not limited to loss of time, inconvenience, lost profits and/or loss of income, freight costs, delivery costs and postage costs. Manufacturer's total liability under this warranty shall not exceed the cost of the manufacturer's trailer product.

### LIMITATION OF LIABILITY

MANUFACTURER EXCLUDES ALL LIABILITY, WHETHER BASED ON CONTRACT (EXPRESSED OR IMPLIED) TORT, OR PRODUCT LIABILITY, FOR ANY DAMAGES TO PURCHASER OR ANY OTHER PARTY OTHER THAN REPAIR OF ANY DEFECTIVE ITEM AS SET FORTH IN THIS WARRANTY. NOR SHALL MANUFACTURER BE LIABLE FOR ANY PUNITIVE, SPECIAL, INDIRECT, INCIDENTAL, OR CONSEQUENTIAL DAMAGES OF

## Warranty Information

ANY KIND OR FOR LOSS OF REVENUE, PROFITS, LOSS OF BUSINESS, LOSS OF USE OF PRODUCT, OR OTHER FINANCIAL LOSS ARISING OUT OF OR IN CONNECTION WITH THE SALE, MAINTENANCE, USE OR FAILURE TO THE PRODUCT, EVEN IF MANUFACTURER HAS BEEN ADVISED OF THE POSSIBILITY OF SUCH DAMAGES. MANUFACTURER'S LIABILITY UNDER THIS WARRANTY THEREFORE DOES NOT INCLUDE, AND SPECIFICALLY EXCLUDES, LIABILITY FOR PURCHASER'S HOTEL OR OTHER LODGING, FOOD AND OTHER LIVING OR TRAVEL EXPENSES, AND FUEL EXPENSES. THIS DISCLAIMER OF LIABILITY SHALL NOT BE AFFECTED EVEN IF ANY REMEDY PROVIDED IN WARRANTY FAILS OF ITS ESSENTIAL PURPOSE.

### **DISCLAIMER OF IMPLIED WARRANTIES**

MANUFACTURER MAKES NO EXPRESSED OR IMPLIED WARRANTIES OTHER THAN AS SPECIFICALLY SET FORTH IN THIS WARRANTY. EXCEPT FOR THE EXPRESSED LIMITED WARRANTY SET FORTH HEREIN, THE PRODUCT IS SOLD "AS IS" AND THIS LIMITED WARRANTY IS GIVEN AS THE EXCLUSIVE WARRANTY AND REMEDY AND SUPERCEDES ALL OTHER WARRANTIES WHETHER EXPRESSED OR IMPLIED AND THE PURCHASER DOES HEREBY RELEASE CIMARRON TRAILER, INC THEREFROM. THERE ARE NO IMPLIED WARRANTIES OF MERCHANTABILITY, FITNESS FOR A PARTICULAR PURPOSE, COMPLIANCE WITH DESCRIPTION, OR NON-INFRINGEMENT IN CONNECTION WITH ANY SALE. THIS LIMITED WARRANTY DOES NOT COVER FAILURE OF THE PRODUCT RESULTING FROM CAUSES OTHER THAN PRODUCT DEFECTS, INCLUDING BUT NOT LIMITED TO IMPROPER MAINTENANCE, IMPROPER USE, OR ANY OTHER SUCH CAUSE. NO ONE INCLUDING AN AUTHORIZED DEALER MAY MAKE FURTHER OR ADDITIONAL WARRANTIES ON BEHALF OF CIMARRON TRAILERS. THE PURCHASER'S EXCLUSIVE REMEDY SHALL BE THAT SET FORTH ABOVE FOR ANY CLAIM OF LIABILITY UNDER NEGLIGENCE, STRICT LIABILITY, BREACH OF WARRANTY OR ANY OTHER LEGAL THEORY. If any provision of this Warranty is held to be illegal or unenforceable by any

## Warranty Information

court of competent jurisdiction, the remaining provisions shall remain effective. Some states do not allow the exclusion or limitation of implied warranties or the limitation of incidental or consequential damages for certain products supplied to consumers or the limitation of liability for personal injury, so the limitations and exclusions above may be limited in their application. When the implied warranties cannot be excluded in their entirety, they will be limited to the duration of the Expressed written terms of this warranty.

### DESIGN CHANGES

Manufacturer reserves the right to change the design of its Products from time to time without notice and with no obligation to make corresponding changes in any Products previously manufactured.

### LEGAL REMEDIES OF PURCHASER

THIS WARRANTY GIVES YOU SPECIFIC LEGAL RIGHTS, AND YOU MAY HAVE OTHER RIGHTS WHICH MAY VARY FROM STATE TO STATE. No action to enforce this Warranty shall be effective if it is commenced later than 180 days after discovery of any defect nor shall any action to enforce this Warranty be effective if after the expiration of the Warranty Periods set forth above.

**Exclusive Remedy.** Purchaser's exclusive remedy for breach of warranty as a result of defects in material and workmanship shall be for manufacturer to repair or replace, at manufacturer's sole option, any part or parts of manufacturer's trailer product that are determined by manufacturer to be defective in material or workmanship. The only persons authorized to make repairs to manufacturer's trailer products covered under this warranty are manufacturer, manufacturer's authorized factory representative, or a service facility approved in writing by the Manufacturer's Warranty Department prior to any repairs being made. If any other party makes repairs to manufacturer's trailer products, this warranty is void. Manufacturer's authorized factory representatives (or other service facility approved by manufacturer) may make repairs or adjustments to a manufacturer's trailer product only after the manufacturer has approved in writing each specific repair and adjustment and has agreed in writing to the cost of each specific repair or adjustment to

## Warranty Information

manufacturer's trailer product. manufacturer is not responsible for purchaser's freight, transportation, delivery or postage cost incurred in the repair or replacement process.

**Procedures for Warranty Claims.** Purchaser shall return the trailer to Dealer for inspection within five (5) days after discovering a problem with their trailer. If Dealer cannot repair the problem, a "warranty claim form" should be submitted to Cimarron Trailers, by registered letter or fax within ten (10) days. Cimarron Trailers, Inc will acknowledge receipt of the claim within thirty (30) days of receipt. Defective part(s) must be sent by prepaid freight to Cimarron Trailers, Inc to qualify for replacement. DEFECTIVE PARTS MUST BE RETURNED TO CIMARRON TRAILERS WITHIN THIRTY (30) DAYS FOR DATE OF APPROVAL TO QUALIFY FOR REPLACEMENT. Cimarron Trailers will reimburse claimant for adjustment or repair of a Cimarron trailer only if written approval is made by Cimarron Trailers. If authorized repairs are made other than at the factory, Cimarron Trailers, does not warrant that repair/replacement.

**Mediation/Arbitration Required.** By signing below, Purchaser hereby accepts and agrees that disputes under this Warranty will first be submitted to a certified Mediator, mutually agreed upon by both parties, which mediation shall take place in Grady County, Oklahoma. Each party to any mediation will pay its own fees, costs and expenses, including attorney's fees, and will equally split the mediator's fees and administrative fees of mediation; and the parties further accept and understand that disputes not resolved by mediation will be settled by neutral, binding arbitration in Grady County, Oklahoma, in accordance with the rules of the American Arbitration Association or other arbitrator agreed upon by the parties. Each part to any arbitration (or litigation to enforce the arbitration provision of this Warranty or an arbitration award) will pay its own fees, costs and expenses, including attorney's fees, and will equally split the arbitrator's fees and administrative fees of arbitration.

THIS WARRANTY SHALL BE GOVERNED BY THE LAWS OF THE STATE OF OKLAHOMA. THE PURCHASER WAIVES ANY OBJECTION TO AND FURTHER SUBMITS TO THE JURISDICTION AND VENUE OF GRADY COUNTY, OKLAHOMA FOR ANY AND ALL JUDICIAL ACTIONS OR PROCEEDINGS TO ENFORCE OR

## Warranty Information

DEFEND ANY MEDIATION AGREEMENT OR ARBITRATION AGREEMENT REFERENCED ABOVE, OR TO ENFORCE THE ARBITRATION PROVISION OF THIS WARRANTY.

The undersigned Dealer, hereby certifies that he/she has explained the limited warranty and claims procedures to the Original Purchaser and will perform all responsibilities of Dealer.

By signing this Manufacturer's Limited Warranty, THE PURCHASER ACKNOWLEDGES THAT HE OR SHE HAS READ THE ABOVE LIMITED WARRANTY AND AGREES THAT, SHOULD ANY WARRANTY CLAIMS BE MADE, PURCHASER WILL FOLLOW THE PROCEDURES AS SET FORTH ABOVE.

Dealer Signature		Dealership	
Product Purchased	VIN of Product	Purchase Date	
Purchaser Name (Printed)		Purchaser Signature	
Purchaser's Address	City	State	Zip
Telephone #	Email Address		

### REQUIRED WARRANTY CLAIM PROCEDURE

10. Within five (5) days after discovering a problem with the trailer, return it for inspection by DEALER.
11. If DEALER cannot repair the problem a "limited warranty claim form" should be submitted to Cimarron Trailers, Inc., by registered letter or fax within ten (10) days.
12. Cimarron Trailers, Inc. will acknowledge receipt of the claim within thirty (30) days of receipt.
13. Defective part(s) must be sent by prepaid freight to Cimarron Trailers, Inc. to qualify for replacement. DEFECTIVE PARTS MUST BE RETURNED TO CIMARRON TRAILERS, INC. WITHIN 30 DAYS FROM DATE OF APPROVAL TO QUALIFY FOR REPLACEMENT.

## Warranty Information

14. Cimarron Trailers, Inc. will reimburse claimant for adjustment or repair of a Cimarron trailer only if written approval is made by Cimarron Trailers, Inc.
15. If authorized repairs are made other than at the factory, Cimarron Trailers, Inc. does not warrant that repair/replacement.

Cimarron Trailers, Inc., makes no other express or implied warranties and there are no other warranties, which extend beyond the description on the face of this limited warranty.

THIS WARRANTY SHALL BE GOVERNED BY THE LAWS OF THE STATE OF OKLAHOMA. JURISDICTION AND VENUE FOR ALL JUDICIAL ACTIONS OR PROCEEDINGS TO ENFORCE OR DEFEND THIS WARRANT SHALL BE IN THE DISTRICT COURT OF GRADY COUNTY, STATE OF OKLAHOMA.



# Service Record



## OWNERS REFERENCE INFORMATION

Owner's Name \_\_\_\_\_

Address \_\_\_\_\_

City \_\_\_\_\_ State \_\_\_\_\_ Zip \_\_\_\_\_

Phone \_\_\_\_\_ E-Mail \_\_\_\_\_

Dealer's Name \_\_\_\_\_ Phone \_\_\_\_\_

Salespersons Name \_\_\_\_\_ Phone \_\_\_\_\_

Trailer Model \_\_\_\_\_

Trailer Type (circle one) Horse Stock Combination Cargo Auto

Trailer: Length \_\_\_\_\_ Width \_\_\_\_\_ Height \_\_\_\_\_

Axles (circle one) Single Tandem Triple

Axle Size \_\_\_\_\_

Tire Size \_\_\_\_\_ Tire Brand \_\_\_\_\_

Vehicle Identification Number (VIN)

**(VIN) 5 P A** \_ \_ \_ \_ \_

Key# \_\_\_\_\_ Location \_\_\_\_\_

Purchase Date \_\_\_\_\_

Warranty Registration Date \_\_\_\_\_

CIMARRON TRAILERS RECOMMENDS THAT ALL PURCHASERS  
RECORD TRAILER INFORMATION FOR FUTURE REFERENCE.







## PRODUCT INFORMATION BULLETIN

### CARE AND UPKEEP OF GEL COAT SURFACED FIBERGLASS REINFORCED PANELS USED IN HORSE TRAILERS

Maintaining the exterior surface of Gel Coat finished panel used on your horse trailers is easy, with a little care and attention to detail. Following the simple periodic maintenance tips and practices listed below you can minimize many of the detrimental effects of the environment and general wear and tear.

Your unit's roof construction is a tough, resilient structural composite core product, surfaced with polyester gel coat paint. Gel Coat is designed for outstanding weather ability and durability.

- Tip #1** Regularly inspect the unit's roof for signs of damage, nicks and scratches or stains.
- Tip #2** Although gel coat is extremely stain resistant, the staining agent should be removed as soon as possible, as prolonged exposure to sunlight can modify some stains, making them more difficult to remove.
- Tip #3** Washing stains with a mild detergent and water is usually sufficient to remove most stains and deposits.
- Tip #4** Wash and wax at least twice yearly to restore gloss and protect the finish. Use only wax recommended for fiberglass and follow instructions carefully. Never wax a gel coat surface in direct sunlight.
- Tip #5** Minor scratches and nicks can be easily repaired and painted over following simple procedures outlined in Fiber-Tech repair manuals and videos. Contact Fiber-Tech Customer Service Dept. at 800-879-4377.

The suggestions and information presented herein, we believe to be reliable. They are offered in good faith but without guarantee since conditions and methods of use of Fiber-Tech products are beyond Fiber-Tech's control. It is recommended that the prospective user determine the suitability of our material, information and suggestions before adapting them on a commercial scale.

file: Product Info Bulletin - Care & Upkeep of FRP Horse Trailers.doc

WEST OFFICES: 3808 N. SULLIVAN RD., BLDG 31, SPOKANE, WA 99216 • PH: (509) 928-8880 • FAX: (509) 924-6133  
EAST OFFICES: 2000 KENSKILL AVE., WASHINGTON COURT HOUSE, OH 43160 • PH: (740) 335-9400 • FAX: (740) 335-4843  
MID WEST MFG: CADILLAC, MI  
[www.fiber-tech.net](http://www.fiber-tech.net)

# CLAD TUFF® PANELS LIMITED WARRANTY

Fiber-Tech Industries, Inc. warrants that under normal use and service, all standard panels that are properly installed and maintained shall be free from delamination of the fiberglass reinforced plastic skin due to defects in workmanship and material for a period of twelve (12) months from the date of shipment, as shown on the invoice, provided Fiber-Tech Industries, Inc. receives written notice of alleged defects within ten (10) business days of discovery and a reasonable opportunity to examine the panel. This warranty is limited to the original material purchaser and under no circumstances runs to any remote purchaser. Under no circumstances may the original material purchaser assign this warranty to a third party without the express written consent of Fiber-Tech Industries, Inc.

Fiber-Tech Industries, Inc. assumes no responsibility for faulty or improper application or installation of their products. Due to the variety of uses and applications for Fiber-Tech Industries, Inc. products, it is the responsibility of the user to determine suitability and provide proper installation of Fiber-Tech Industries, Inc. products for the user's particular application. This warranty does not cover damage from the following non-exclusive list of causes:

- Accident, direct impact, or misuse;
- Improper use;
- Improper installation;
- Painting or other alterations to the panel;
- Surface blistering, cracking, crazing, chalking, fading, or discoloration;
- Normal fading or chalking caused by atmospheric conditions;
- Exposure to harmful chemicals or use of improper cleaning agents;
- Discoloration caused by adhesives, glues, sealants, trim, or other products installed on or near the panel;
- Abnormal use of the vehicle or finished product subjecting the panel to excessive wear and tear;
- Acts of God, war, terrorism, riots, or vandalism.

This warranty does not cover any claims regarding post-applied scuff liner or post-applied coatings. This warranty is void upon application of dark colors to the panel, failure to provide reasonable and necessary maintenance, or failure to properly maintain the finish of the panel according to Fiber-Tech Industries, Inc.'s published care and maintenance manual.

Fiber-Tech Industries, Inc. must be notified in writing within ten (10) business days of discovery of the delamination accompanied with proof of purchase and statement of alleged defect at: 3808 N. Sullivan Rd., Bldg #31, Spokane, WA 99216-1615, or by fax: 509-926-7628.

## LIMITED REMEDY

Fiber-Tech Industries, Inc. will repair, provide one replacement panel, or at its option, refund the purchase price of any standard CLAD TUFF®, CLAD FOAM®, FIBERFORM®, FIBERDECK®, RIBBED FOAM, HONEYCOMB, or STRATOPLY SUPER ROOF panel found to be delaminated due to defects in workmanship or materials under the terms, conditions and limitations of this warranty. In no event shall Fiber-Tech Industries, Inc.'s liability exceed the original purchase price for the defective panels.

Fiber-Tech Industries, Inc. has limited the remedy to that contained in this Limited Warranty. Fiber-Tech Industries, Inc. shall not, under any circumstances, be liable for any incidental, consequential or special damage resulting from the use, service or failure of any panel, including without limitation, travel expenses, transportation costs, rental of vehicles and/or equipment, and freight costs.

## EXCLUSION OF OTHER WARRANTIES

THERE ARE NO WARRANTIES WHICH EXTEND BEYOND WHAT IS DESCRIBED ON THE FACE OF THIS LIMITED WARRANTY. THE FOREGOING LIMITED WARRANTY IS IN LIEU OF ALL OTHER WARRANTIES, WHETHER EXPRESS (ORAL OR IN WRITING) OR IMPLIED, INCLUDING WITHOUT LIMITATION, WARRANTIES OF MERCHANTABILITY AND FITNESS FOR PARTICULAR PURPOSE. Any representations or promises inconsistent with or in addition to this warranty are unauthorized and are not binding on Fiber-Tech Industries, Inc.

Claim Notification:

Fiber-Tech Industries, Inc.

2000 Kenskill Ave.  
Washington Court House, OH 43160  
Phone: 740-335-9400  
Fax: 740-335-4843

3808 N. Sullivan Rd., Bldg #31  
Spokane, WA 99216-1615  
Phone: 509-928-8880  
Fax: 509-924-6133

Effective: June 1, 2012

**NWR** | **NORTH WEST RUBBER**  
INNOVATIVE RUBBER PRODUCTS



## WARRANTY

North West Rubber warrants each mat it sells to be free of defective materials and workmanship and agrees to replace mats which under normal wear disclose such defect. This is a **lifetime warranty** given to the original purchaser. North West Rubber shall not be responsible for any loss, inconvenience, or consequential damage caused by product. This warranty is in lieu of any other warranty, obligation or liability expressed or implied, including any warranty of merchantability or fitness for a particular purpose other than trailer floor mats. Manufacturer will not accept responsibility for more than product replacement FOB Abbotsford, BC Canada.

33850 Industrial Ave.  
Abbotsford, BC  
Canada V2S 7T9

P 604.859.2002  
F 604.859.2009  
**1.800.663.8724**

For other products visit us at  
[www.northwestrubber.com](http://www.northwestrubber.com)  
[sales@northwestrubber.com](mailto:sales@northwestrubber.com)